

METTLER TOLEDO

Table of Contents

1	Introduction	3
1.1	Further documents and information	3
1.2	Explanation of conventions and symbols used	3
1.3	Acronyms and abbreviations	4
1.4	Compliance information	4
2	Safety Information	5
2.1	Definitions of signal words and warning symbols	5
2.2	Product-specific safety notes	5
3	Design and Function	7
3.1	Overview	7
3.1.1	Overview balance	7
3.1.2	Overview type plate	8
3.1.3	Operation keys	8
3.1.4	Display	10
3.2	Basic principles for operation	11
4	Installation and Putting into Operation	14
4.1	Selecting the location	14
4.2	Scope of delivery	14
4.3	Unpacking the balance	15
4.4	Installing components	15
4.5	Installing protective cover	18
4.6	Connecting the balance	19
4.7	Setting up the balance	20
4.7.1	Switching on the balance	20
4.7.2	Leveling the balance	20
4.7.3	Setting date and time	21
4.7.4	Adjusting the balance	22
4.8	Adjustment (calibration)	22
4.8.1	Adjustment with internal weight	22
4.8.2	Adjustment with external weight	22
4.8.3	Customer fine adjustment (model dependent)	23
4.9	Performing a simple weighing	25
4.10	Transporting the balance	27
4.10.1	Transporting over short distances	28
4.10.2	Transporting over long distances	28
4.10.3	Packaging and storage	28
4.11	Weighing below the balance	28
5	The Menu	30
5.1	What is in the menu ?	30
5.2	Description of menu topics	31
5.2.1	Main menu	31
5.2.2	Basic menu	31
5.2.3	Advanced menu	33
5.2.4	Interface menu	35
6	Applications	39
6.1	Application piece counting	39
6.2	Application percent weighing	42
6.3	Application check weighing	44
6.4	Application statistics	46
6.5	Application totaling	48
6.6	Application multiplication factor weighing	50

6.7	Application division factor weighing	52
6.8	Application density.....	54
6.8.1	Density determination of solids	54
6.8.2	Density determination of liquids	56
6.8.3	Formulae used to calculate density	56
7	Communication with Peripheral Devices	59
7.1	PC-Direct function	59
7.2	Send weight value via RS232 to a PC using EasyDirect balance	61
8	Maintenance	63
8.1	Maintenance table.....	63
8.2	Performing routine tests	63
8.3	Cleaning	63
8.3.1	Cleaning the glass draft shield	64
8.3.2	Cleaning the balance	64
8.3.3	Putting into operation after cleaning	65
9	Troubleshooting	66
9.1	Error messages	66
9.2	Error symptoms	67
9.3	Status icons	70
9.4	Putting into operation after fixing an error.....	70
10	Technical Data	71
10.1	General data	71
10.2	Model-specific data.....	72
10.2.1	Gold balances with readability of 0.01 mg.....	72
10.2.2	Carat balances with readability of 0.001 ct / 0.1 mg	73
10.2.3	Gold balances with readability of 0.1 mg and 1 mg.....	76
10.2.4	Gold balances with readability of 10 mg.....	80
10.3	Dimensions.....	85
10.3.1	Gold balances with readability of 0.01 mg.....	85
10.3.2	Carat balances with readability of 0.001 ct / 0.1 mg	86
10.3.3	Gold balances with readability of 0.1 mg and 1 mg.....	87
10.3.4	Gold balances with readability of 10 mg.....	88
10.4	Interface specification	89
10.4.1	RS232C interface	89
10.4.2	MT-SICS interface commands and functions	89
11	Accessories and Spare Parts	90
11.1	Accessories.....	90
11.2	Spare parts	93
12	Disposal	96
	Index	97

1 Introduction

Thank you for choosing a METTLER TOLEDO balance. The balance combines high performance with ease of use.

This document is based on the software version V 1.20.

EULA

The software in this product is licensed under the METTLER TOLEDO End User License Agreement (EULA) for Software.

▶ www.mt.com/EULA

When using this product you agree to the terms of the EULA.

1.1 Further documents and information

▶ www.mt.com/jewelry

This document is available in other languages online.

▶ www.mt.com/JE-RM

Search for software

▶ www.mt.com/labweighing-software-download

Search for documents

▶ www.mt.com/library

For further questions, please contact your authorized METTLER TOLEDO dealer or service representative.

▶ www.mt.com/contact

1.2 Explanation of conventions and symbols used

Conventions and symbols

Key and/or button designations and display texts are shown in graphic or bold text, e.g.,  **DATE**.

 **Note** For useful information about the product.



Refers to an external document.



This symbol indicates press key briefly (less than 1.5 s).



This symbol indicates press and hold key down (longer than 1.5 s).



This symbol indicates a flashing display.

Elements of instructions

In this manual, step-by-step instructions are presented as follows. The action steps are numbered and can contain prerequisites, intermediate results and results, as shown in the example. Sequences with less than two steps are not numbered.

- Prerequisites that must be fulfilled before the individual steps can be executed.

1 Step 1

➔ Intermediate result

2 Step 2

➔ Result

1.3 Acronyms and abbreviations

Original term	Explanation
ASTM	American Society for Testing and Materials
EMC	Electromagnetic Compatibility
FCC	Federal Communications Commission
GWP	Good Weighing Practice
ID	Identification
LPS	Limited Power Source
MT-SICS	METTLER TOLEDO Standard Interface Command Set
OIML	Organisation Internationale de Métrologie Légale (International Organization of Legal Metrology)
RM	Reference Manual
SNR	Serial Number
SOP	Standard Operating Procedure
UM	User Manual
USB	Universal Serial Bus

1.4 Compliance information

National approval documents, e.g., the FCC Supplier Declaration of Conformity, are available online and/or included in the packaging.

► <http://www.mt.com/ComplianceSearch>

European Union

The instrument complies with the directives and standards listed on the EU Declaration of Conformity.

United States of America

This equipment has been tested and found to comply with the limits for a **Class A** digital device, pursuant to part 15 of the FCC Rules. These limits are designed to provide reasonable protection against harmful interference when the equipment is operated in a commercial environment. This equipment generates, uses, and can radiate radio frequency energy and, if not installed and used in accordance with the instruction manual, may cause harmful interference to radio communications. Operation of this equipment in a residential area is likely to cause harmful interference in which case the user will be required to correct the interference at his own expense.

Changes or modifications not expressly approved by the party responsible for compliance could void the user's authority to operate the equipment.

2 Safety Information

Two documents named "User Manual" and "Reference Manual" are available for this instrument.

- The User Manual is printed and delivered with the instrument.
- The electronic Reference Manual contains a full description of the instrument and its use.
- Keep both documents for future reference.
- Include both documents if you transfer the instrument to other parties.

Only use the instrument according to the User Manual and the Reference Manual. If you do not use the instrument according to these documents or if the instrument is modified, the safety of the instrument may be impaired and Mettler-Toledo GmbH assumes no liability.

2.1 Definitions of signal words and warning symbols

Safety notes contain important information on safety issues. Ignoring the safety notes may lead to personal injury, damage to the instrument, malfunctions and false results. Safety notes are marked with the following signal words and warning symbols:

Signal words

DANGER	A hazardous situation with high risk, resulting in death or severe injury if not avoided.
WARNING	A hazardous situation with medium risk, possibly resulting in death or severe injury if not avoided.
CAUTION	A hazardous situation with low risk, resulting in minor or moderate injury if not avoided.
NOTICE	A hazardous situation with low risk, resulting in damage to the instrument, other material damage, malfunctions and erroneous results, or loss of data.

Warning symbols



General hazard: read the User Manual or the Reference Manual for information about the hazards and the resulting measures.



Electrical shock



Notice

2.2 Product-specific safety notes

Intended use

This instrument is designed to be used by trained staff. The instrument is intended for weighing purposes.

Any other type of use and operation beyond the limits of use stated by Mettler-Toledo GmbH without consent from Mettler-Toledo GmbH is considered as not intended.

Responsibilities of the instrument owner

The instrument owner is the person holding the legal title to the instrument and who uses the instrument or authorizes any person to use it, or the person who is deemed by law to be the operator of the instrument. The instrument owner is responsible for the safety of all users of the instrument and third parties.

Mettler-Toledo GmbH assumes that the instrument owner trains users to safely use the instrument in their workplace and deal with potential hazards. Mettler-Toledo GmbH assumes that the instrument owner provides the necessary protective gear.

Safety notes



WARNING

Death or serious injury due to electric shock

Contact with parts that carry a live current can lead to death or injury.

- 1 Only use the METTLER TOLEDO power cable and AC/DC adapter designed for your instrument.
- 2 Connect the power cable to a grounded power outlet.
- 3 Keep all electrical cables and connections away from liquids and moisture.
- 4 Check the cables and the power plug for damage and replace them if damaged.



NOTICE

Damage to the instrument or malfunction due to the use of unsuitable parts

- Only use parts from METTLER TOLEDO that are intended to be used with your instrument.



NOTICE

Damage to the instrument or software

In some countries, excessive mains voltage fluctuations and strong glitches may occur. This may affect the instrument functions or damage the software.

- Use a voltage regulator for stabilizing.

3 Design and Function

3.1 Overview

3.1.1 Overview balance

0.001 ct / 0.1 mg
0.0001 ct / 0.01 mg

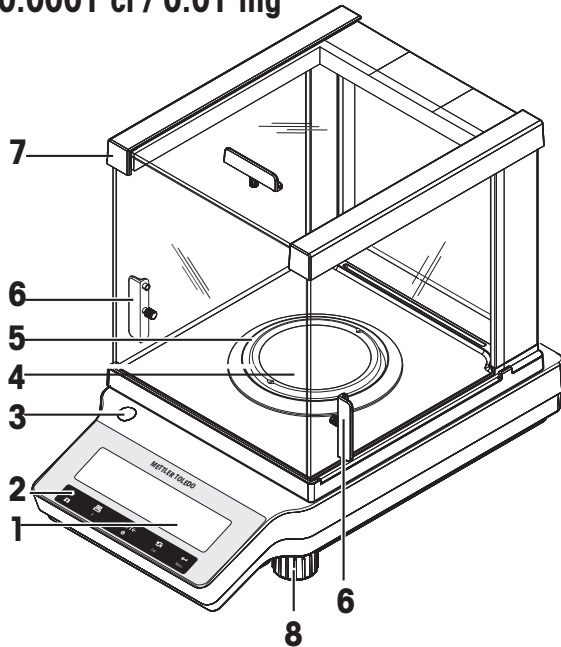

1 mg

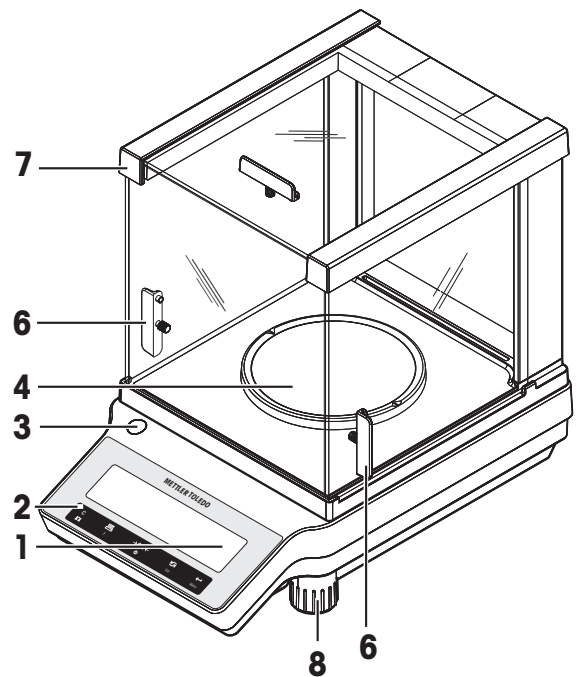

10 mg

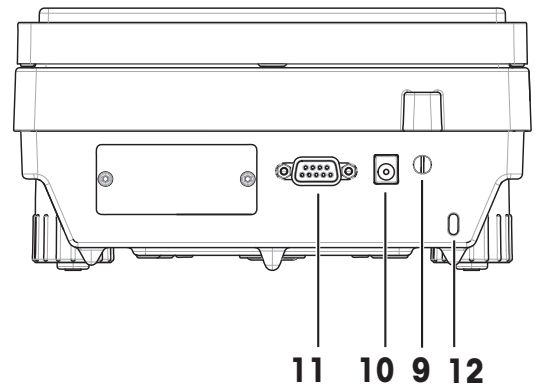
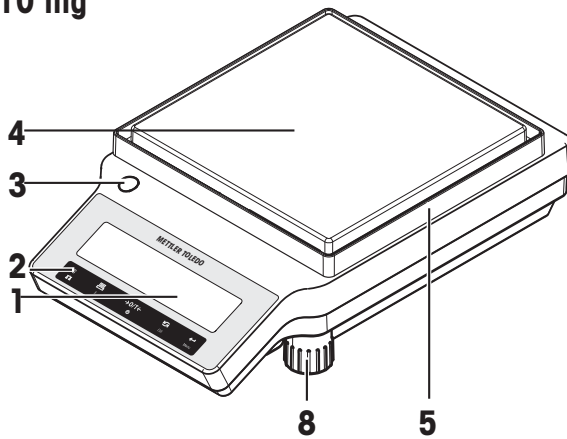

1	Display	2	Operation keys
3	Level indicator	4	Weighing pan
5	Draft shield element	6	Handle for operation of the draft shield door
7	Glass draft shield	8	Leveling foot
9	Legal for trade (LFT) sealing	10	Socket for AC/DC adapter
11	RS232C serial interface	12	Kensington slot for anti-theft purposes

3.1.2 Overview type plate

The balance type plate is located at the side of the balance and contains the following information (example illustration):

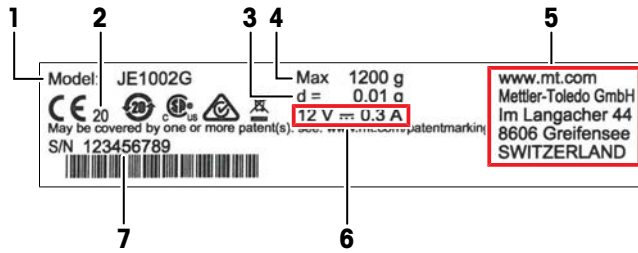



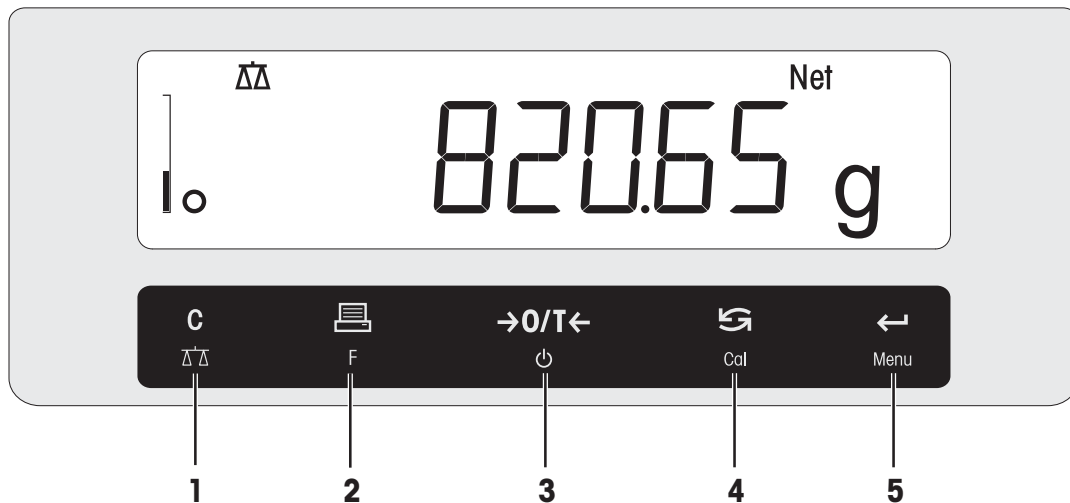

1	Model designation	5	Manufacturer
2	Year of manufacture	6	Power supply
3	Readability	7	Serial number (SNR)
4	Maximum capacity		

3.1.3 Operation keys



Legend key functions

No.	Key	Press briefly (less than 1.5 s)	Press and hold (longer than 1.5 s)
1	C $\Delta\Delta$	<ul style="list-style-type: none"> Cancel or leave menu without saving One step back in the menu 	<ul style="list-style-type: none"> Select the simple weighing application Exit application
2	 F	<ul style="list-style-type: none"> Print display value Transmit data To navigate backwards in the menu or menu selection Decrease parameters in menu or applications 	<ul style="list-style-type: none"> Open the application list for selecting an application
3	$\rightarrow 0/T \leftarrow$ ⏻	<ul style="list-style-type: none"> Zero/Tare Switch on 	<ul style="list-style-type: none"> Switch off into standby mode

No.	Key	Press briefly (less than 1.5 s) 	Press and hold (longer than 1.5 s) 
4	 Cal	<ul style="list-style-type: none"> • With entries, scroll down • To navigate forward menu topics or menu selections • To toggle between unit 1, recall value (if selected), unit 2 (if different from unit 1) and the application unit (if any) • Increase parameters in menu or applications. 	<ul style="list-style-type: none"> • Select adjustment <ul style="list-style-type: none"> – with internal weight * – with external weight – Customer fine adjustment *
5	 Menu	<ul style="list-style-type: none"> • Enter or leave menu selection • To enter application parameter digit and switch to next parameter digit • To accept parameter in menu selection. 	<ul style="list-style-type: none"> • Enter or leave menu (parameter settings) • To store parameter • To accept numeric inputs in applications.

* On models with internal weight only

3.1.4 Display

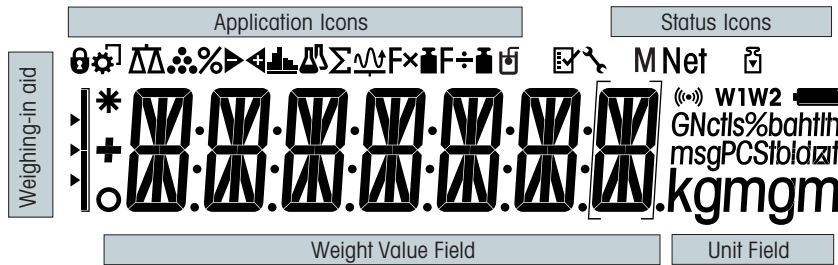

Application icons			
	Application weighing		Application totaling
	Application piece counting		Application multiplication factor
	Application percent weighing		Application division factor
	Application check weighing		Application density
	Application statistics		Menu locked

While an application is running, the corresponding application icon appears at the top of the display.

Status icons			
	Indicates stored value (Memory)		Acoustic feedback for pressed keys activated
	Adjustments (calibration) started	W1	Weighing range 1 (Dual Range models only)
	Service reminder	W2	Weighing range 2 (Dual Range models only)

Weight value field and weighing-in aid			
	Indicates negative values		Brackets to indicate uncertified digits (approved models only)
	Indicates unstable values		Marking of nominal or target weight
	Indicates calculated values		Marking of tolerance limit T+
			Marking of tolerance limit T-

Unit field						
	g	gram	ozt	troy ounce	tls	Singapore taels
	kg	kilogram	GN	grain	tlt	Taiwan taels
	mg	milligram	dwt	pennyweight	tola	tola
	ct	carat	mom	momme	baht	baht
	lb	pound	msg	mesghal		
	oz	ounce	tlh	Hong Kong taels		

3.2 Basic principles for operation

Selecting simple weighing or terminate application

- Press and hold $\Delta\Delta$ until **WEIGH** appears on the display.
 - ➔ The balance returns to the simple weighing mode.

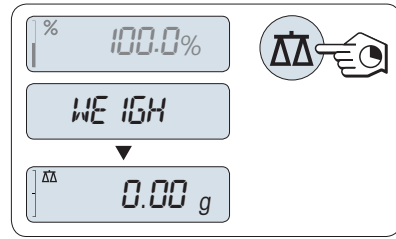

Note

How to perform simple weighing **see** Performing a simple weighing.

Selecting an application

- 1 Press and hold **F** until **APP.LIST** (application list) appears on the display.
 - ➔ Last active application, e.g., **COUNT** appears on the display.
- 2 Select an application by multiple pressing ↻.
- 3 Press ↵ to execute selected application.

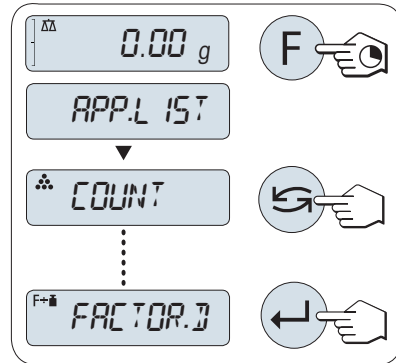

Available applications

Display	Remark	Description
COUNT	Piece counting	see application piece counting
PERCENT	Percent weighing	see application percent weighing
CHECK	Check weighing	see application check weighing
STAT	Statistics	see application statistics
TOTAL	Totaling	see application totaling
FACTOR.M	Multiplication factor	see application multiplication factor weighing
FACTOR.D	Division factor	see application division factor weighing
DENSITY	Density	see application density

Entering the menu

- 1 Press and hold **Menu** to enter main menu.
 - ➔ The first menu **BASIC** is displayed (except menu protection is active).
- 2 Press ↻ repeatedly to change menu.
- 3 Press ↵ to confirm the selection.

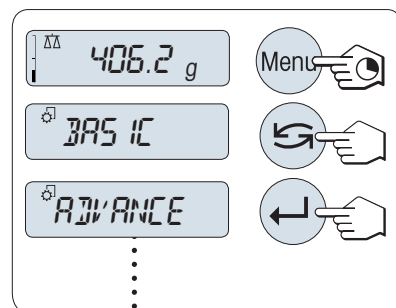



Note

Detailed description of the menu **see** [The Menu ▶ Page 30].

Selecting menu topics

- 1 Press .
 - ➔ The next menu topic appears in the display.
- 2 Press repeatedly, the balance switches to the next menu topic.

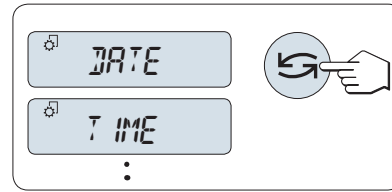

Changing settings in selected menu topic

- 1 Press .
 - ➔ The display shows the current setting in the selected menu topic.
- 2 Press repeatedly, the balance switches to the next selection.
 - ➔ After the last selection, the first is shown again.
- 3 Press to confirm the setting.

To save the settings, see "Saving settings and closing the menu".

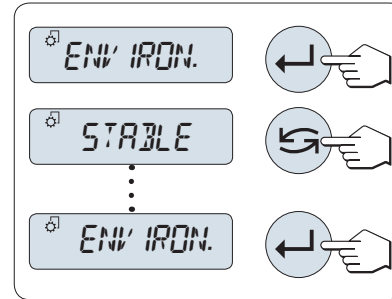

Changing settings in a submenu selection

The same procedure as for menu topics.

Input principle of numerical values

- 1 Press to select a digit (cyclically from left to right) or a value (depending on the application).
 - ➔ The selected digit or the selected value is blinking.
- 2 Press to increase or **F** to decrease for changing blinking digits or values.
- 3 Press and hold to confirm the value.

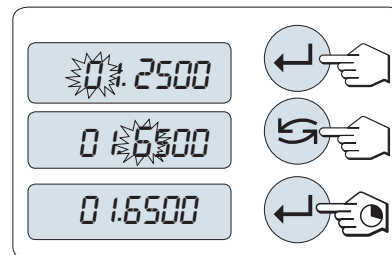

Saving settings and closing the menu

- 1 Press and hold **Menu** to leave menu topic.
 - ➔ **SAVE:YES** appears on the display.
- 2 Press to toggle between **SAVE:YES** and **SAVE:NO**.
- 3 Press to execute **SAVE:YES**.
 - ➔ Changes are saved.
- 4 Press to execute **SAVE:NO**.
 - ➔ Changes are not saved.

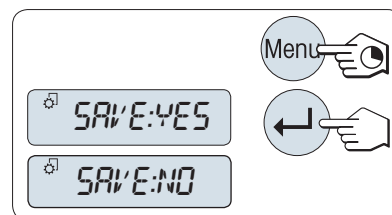

Cancel

- During menu operation
- 1 Press **C** for leaving menu topic or menu selection without saving (one step back in the menu).
 - 2 To leave menu topic or menu selection without saving press **C** (one step back in the menu).
- During application operation
- Press **C** to cancel settings.

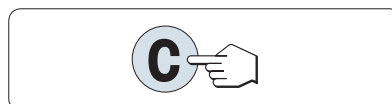

- ➔ The balance returns to the previous active application.



Note

If no entry is made within 30 seconds, the balance reverts to last active application mode. Changes are not saved. If changes are made, the balance asks **SAVE:NO**.

4 Installation and Putting into Operation

4.1 Selecting the location

A balance is a sensitive precision instrument. The location where it is placed will have a profound effect on the accuracy of the weighing results.

Requirements of the location

Place indoors on stable table

Ensure sufficient spacing

Level the instrument

Provide adequate lighting



Avoid direct sunlight

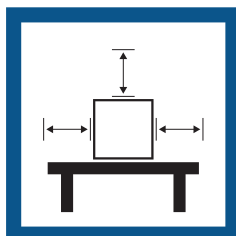

Avoid vibrations



Avoid strong drafts

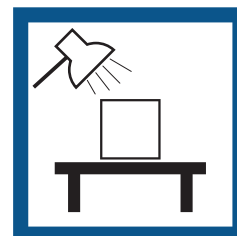

Avoid temperature fluctuations

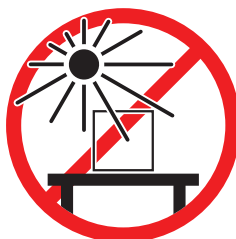

Take into account the environmental conditions. See "Technical Data".

Sufficient spacing for balances: > 15 cm all around the instrument

4.2 Scope of delivery

Components		Carat balances		Gold balances		
		0.1 mct / 1 mct	0.001 ct	0.01 mg / 0.1 mg	1 mg	10 mg
Draft shield	170 mm	✓	✓	✓	✓	–
Weighing pan	ø 80 mm	✓	–	✓	–	–
	ø 90 mm	–	✓	–	–	–
	ø 120 mm	–	–	–	✓	–
	180 × 180 mm	–	–	–	–	✓
Draft shield element		✓	✓	✓	–	✓
Pan support		–	–	–	–	✓
Protective cover		✓	✓	✓	✓	✓
Universal AC adapter (with plug set)		✓	✓	✓	✓	✓

Components		Carat balances		Gold balances		
Carat pan	S 80 \varnothing \times 20 mm	–	✓	–	–	–
	M 90 \varnothing \times 30 mm	–	✓	–	–	–
	L 90 \varnothing \times 45 mm	–	✓	–	–	–
User Manual		✓	✓	✓	✓	✓
Declaration of conformity		✓	✓	✓	✓	✓

4.3 Unpacking the balance

Open the balance packaging. Check the balance for transport damage. Immediately inform a METTLER TOLEDO representative in the event of complaints or missing accessories.

Retain all parts of the packaging. This packaging offers the best possible protection for transporting the balance.

4.4 Installing components



CAUTION

Injury due to breaking glass

Careless handling of the glass components can lead to breakage off glass and damage cuttings.

- Always proceed focused and with care.

Balances with readability of 0.0001 ct / 0.01 mg and 0.001 ct / 0.1 mg

Place the following components on the balance in the specified order:

- 1 Push the side glass doors back as far as they will go.
- 2 Place draft shield element (1).
- 3 Place weighing pan (2).

Further information for cleaning the draft shield, see chapter "Cleaning the glass draft shield".

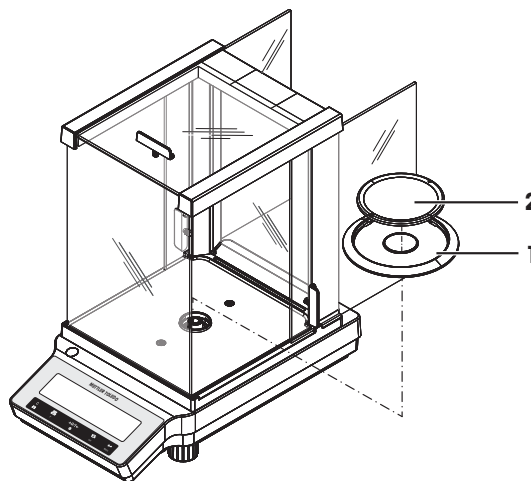

Balances with readability of 1 mg

Place the following components on the balance in the specified order:

- 1 Push the side glass doors back as far as they will go.

2 Place weighing pan (1).

Further information for cleaning the draft shield, **see** chapter "Cleaning the glass draft shield".

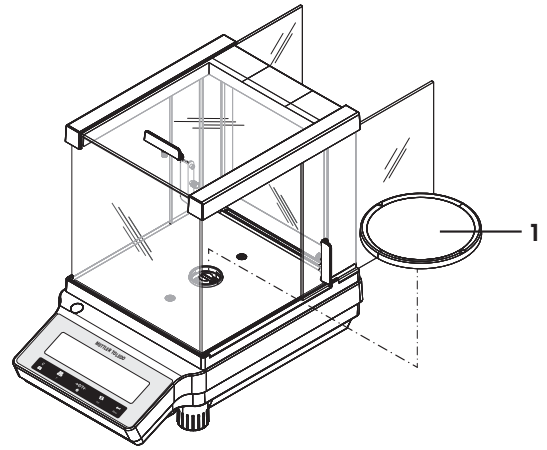

Gold balances with readability of 10 mg

Place the following components on the balance in the specified order:

- 1 Place draft shield element (1): carefully pull apart the draft shield element to fix it under the retaining plate.
- 2 Insert pan support (2).
- 3 Place weighing pan (3).

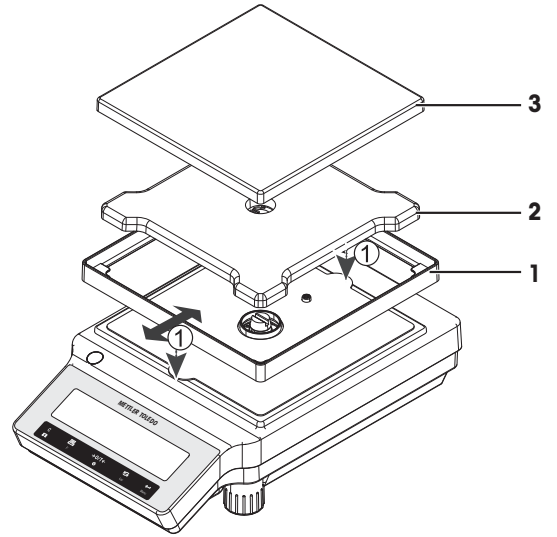

4.5 Installing protective cover



NOTICE

Damage to the instrument or malfunction due to the use of unsuitable parts

- Only use parts from METTLER TOLEDO that are intended to be used with your instrument.

Make sure using the correct protective cover, **see** [Accessories and Spare Parts ▶ Page 90].

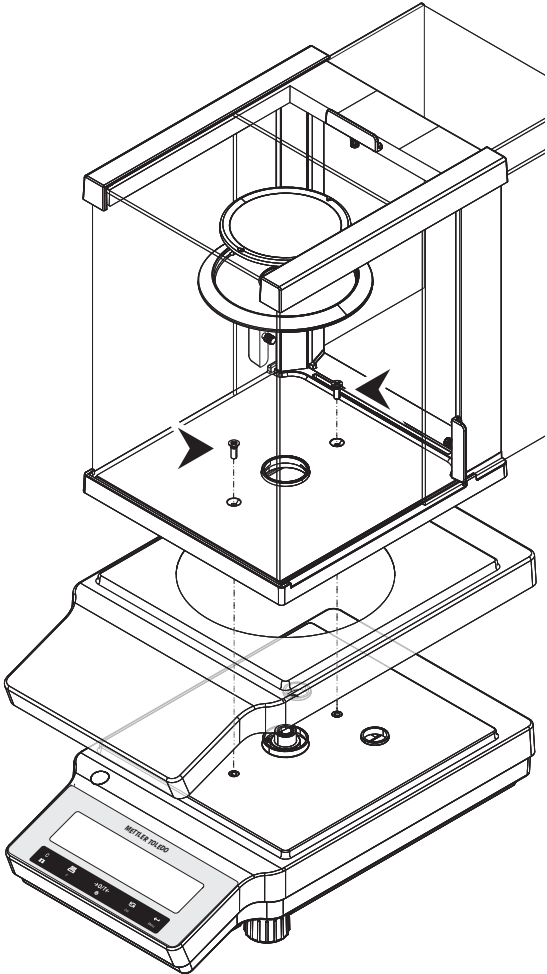
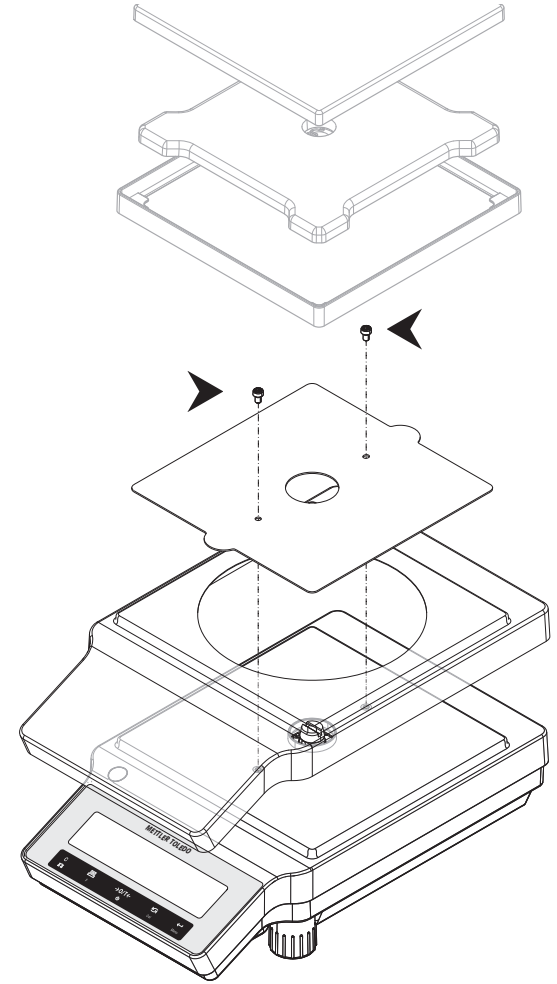
Balances with draft shield	Balances without draft shield
<p data-bbox="261 474 850 542">Install the protective cover according to the illustrations below, using a screwdriver Philips No. 2.</p> 	<p data-bbox="850 474 1447 542">Install the protective cover according to the illustrations below, using a screwdriver Torx TX20.</p> 

4.6 Connecting the balance



WARNING

Death or serious injury due to electric shock

Contact with parts that carry a live current can lead to death or injury.

- 1 Only use the METTLER TOLEDO power cable and AC/DC adapter designed for your instrument.
- 2 Connect the power cable to a grounded power outlet.
- 3 Keep all electrical cables and connections away from liquids and moisture.
- 4 Check the cables and the power plug for damage and replace them if damaged.



NOTICE

Damage to the AC/DC adapter due to overheating

If the AC/DC adapter is covered or in a container, it is not sufficiently cooled and will overheat.

- 1 Do not cover the AC/DC adapter.
- 2 Do not put the AC/DC adapter in a container.

- Install the cables so that they cannot be damaged or interfere with operation.
 - Insert the power cable in a grounded power outlet that is easily accessible.
- 1 Connect the AC/DC adapter (1) to the connection socket on the back of your balance.
 - 2 Connect the power cable (2) to the power socket.
 - ➔ The balance performs a display test (all segments in the display light up briefly), **WELCOME**, **Software version**, **Maximum load** and **Readability** appears briefly.
 - ➔ The balance is ready to be used.

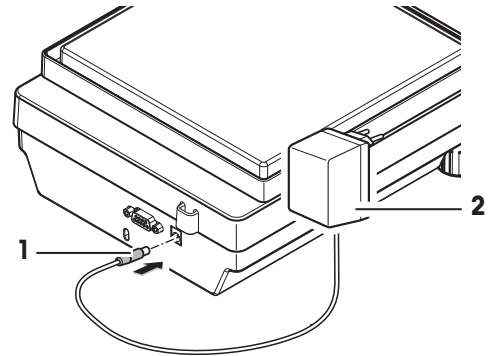

Note

Always connect the AC/DC adapter to the balance before connecting to the power.

Do not connect the instrument to a power outlet controlled by a switch. After switching on the instrument, it must warm up before giving accurate results.

4.7 Setting up the balance

4.7.1 Switching on the balance

Before using the balance, it must be warmed up in order to obtain accurate weighing results. To reach operating temperature, the balance must be connected to the power supply for at least 30 minutes (60 minutes for 0.1 mg / 0.01 mg models).

- The balance is connected to the power supply.
- The balance is in **STANDBY** mode. **MT.GREEN** appears on the display.
- Press .
- ➔ The balance is ready for weighing or for operation with the last active application.

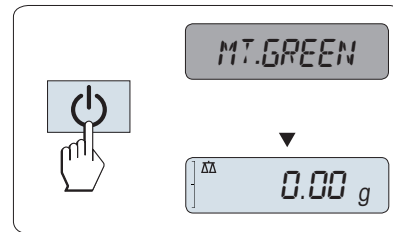

Legal-for-trade

Approved balances can only be switched on by pressing  in selected countries.

4.7.2 Leveling the balance

Exact horizontal and stable positioning are essential for repeatable and accurate weighing results. There are two adjustable leveling feet to compensate for slight irregularities in the surface of the weighing bench.

The balance must be leveled and adjusted each time it is moved to a new location.

- 1 Position the balance at the selected location.
- 2 Align the balance horizontally.
- 3 Turning the two front leveling feet of the housing until the air bubble is in the middle of the glass.

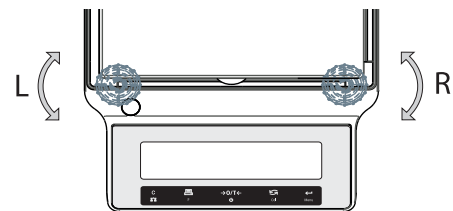

Example

Air bubble at 12 o'clock:



turn both feet clockwise.



Air bubble at 3 o'clock:



turn left foot clockwise, right foot counterclockwise.



Air bubble at 6 o'clock:



turn both feet counterclockwise.



Air bubble at 9 o'clock:



turn left foot counterclockwise, right foot clockwise.



4.7.3 Setting date and time

When you put your new instrument into operation for the first time, you should enter the current date and time.

Note

- These settings are retained even if you disconnect your instrument from the power supply.
- A reset of the instrument will not change these settings.
- Set the current date according to the date format **DATE.FRM** in the menu **ADVANCE..**
- Set the current time according to the time format **TIME.FRM** in the menu **ADVANCE..**

- 1 Press and hold **Menu** until menu **BASIC** appears on the display.
- 2 Press **←** to open menu **BASIC**.
→ **DATE** appears.
- 3 Press **←** to confirm.
- 4 **Set current date.** Press **←** to select day, month or year; press **↻** to set current day, month or year.
- 5 Press and hold **←** to confirm the settings.
→ **DATE** appears..
- 6 **Set current time.** Press **↻** to select **TIME**.
- 7 Press **←** to confirm.
→ **+1H** appears.
- 8 Select **SET.TIME** by pressing **↻**.
- 9 Press **←** to confirm.
- 10 Press **←** to select hours or minutes; press **↻** to set current hours or minutes.
- 11 Press and hold **←** to confirm the settings.
→ **TIME** appears.
- 12 Press and hold **←** to store the settings.
→ **SAVE:YES** appears.
- 13 Press **←** to confirm.

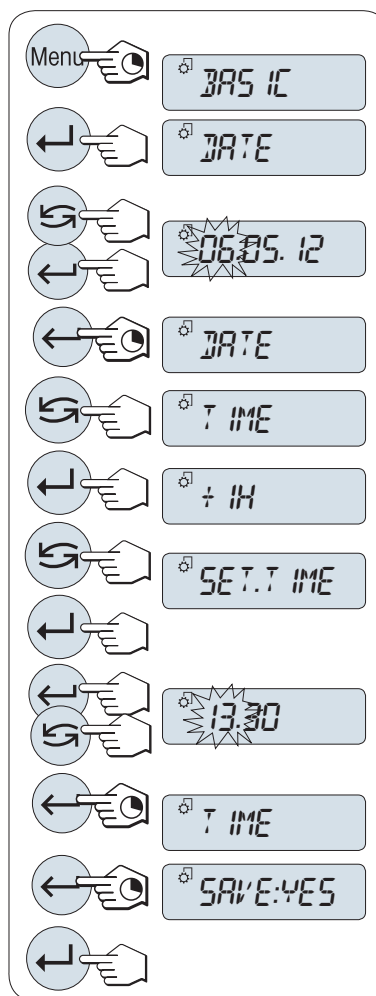

4.7.4 Adjusting the balance

To obtain accurate weighing results, the balance must be adjusted to match the gravitational acceleration at its location. This is also dependent on the ambient conditions. After reaching the operating temperature, it is important to adjust the balance in the following cases:

- Before the balance is used for the first time.
- If the balance has been disconnected from the power supply or in the event of power failure.
- After significant environmental changes, e.g., temperature, humidity, air draft or vibrations.
- At regular intervals during weighing service.

4.8 Adjustment (calibration)



NOTICE



Before adjusting the balance, it must be warmed up.

4.8.1 Adjustment with internal weight



Note

On models with internal weight only, see chapter "Technical Data".

- Weighing pan is unloaded.
- 1 Press and hold **CAL** until **ADJUST** appears.
 - 2 Select **ADJ.INT** by pressing 
 - ➔ **ADJ.INT** appears on the display.
 - 3 Press  to execute internal adjustment.
 - ➔ The adjusting is finished when the message **ADJ.DONE** appears briefly on the display. The balance returns to the last active application and is ready for operation.

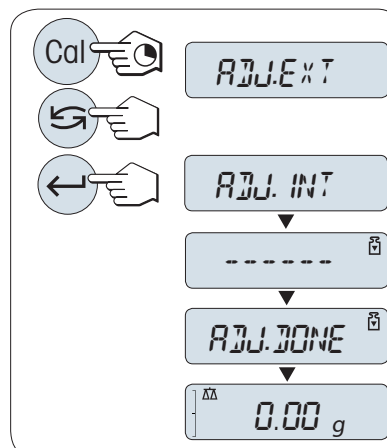





4.8.2 Adjustment with external weight



Note

Because of certification legislation, the approved models cannot be adjusted with an external weight * (depend on selected countries' certification legislation).

* except OIML accuracy class I approved models.

- Required adjustment weight is ready.
 - Weighing pan is unloaded.
- 1 Press and hold **CAL** until **ADJUST** appears.
 - 2 Select **ADJ.EXT** by pressing .
 - ➔ **ADJ.EXT** appears on the display.
 - 3 Unload weighing pan.
 - 4 Optional: If necessary, you can define a different weight value. Press  to change a digit (cyclically from left to right); press  to change the blinking digit.
 - 5 Press and hold  to execute external adjustment.
 - ➔ The required adjustment weight value flashes in the display.
 - 6 Place adjustment weight in center of pan.
 - ➔ The balance adjusts itself automatically.
 - 7 When zero is flashing, remove adjustment weight.
 - ➔ The adjusting is finished when the message **ADJ.DONE** appears briefly on the display. The balance returns to the last active application and is ready for operation.

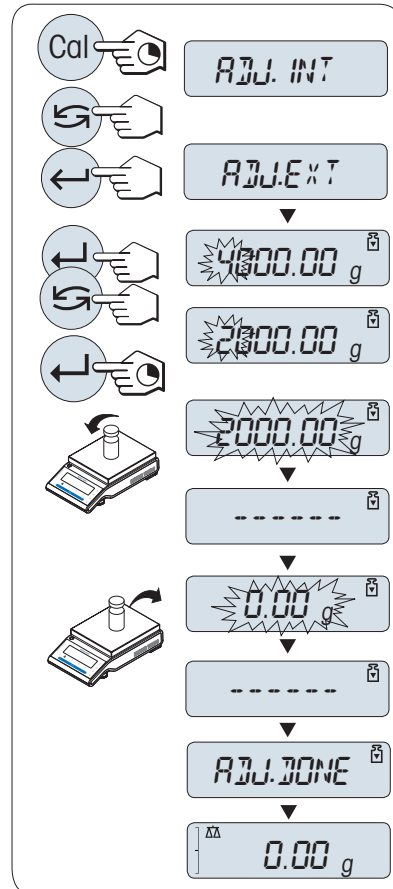

4.8.3 Customer fine adjustment (model dependent)



NOTICE





This function should be executed only by trained personnel.

The function customer fine adjustment **ADJ.CF** allows you to adjust the value of the internal adjustment weight with your own adjustment weight. The adjustable range of the adjustment weight is possible only in a very small range. Customer fine adjustment impacts the function of internal adjustment. The customer fine adjustment can be deactivated at any time.

Note

- This feature is available on models with internal weight only.
- Because of certification legislation, approved models cannot be adjusted with customer fine adjustment (depending on selected countries' certification legislation).
- Use certificated weights.
- Balance and test weight have to be on operating temperature.
- Observe the correct environmental conditions.

Execute customer fine adjustment

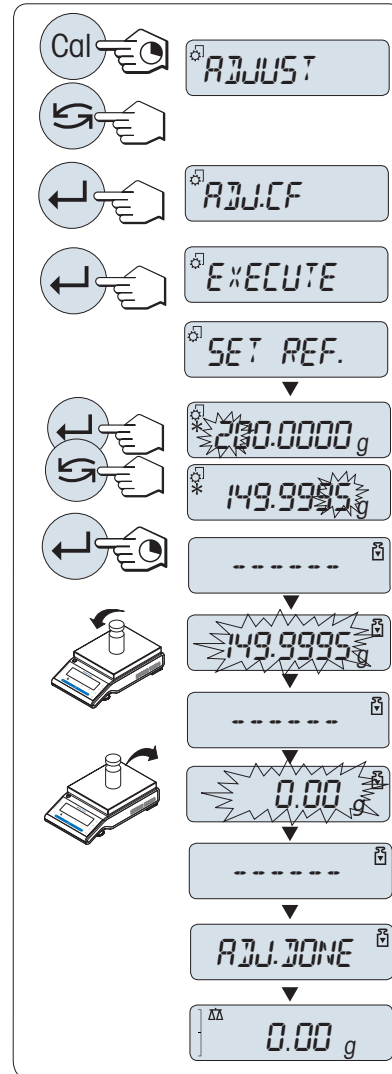

- The balance is under measuring condition.
 - Required adjustment weight is ready.
 - Weighing pan is unloaded.
- 1 Press and hold **CAL** until **ADJUST** appears.
 - 2 Select **ADJ.CF** by pressing 
 - ➔ **ADJ.CF** appears on the display.
 - 3 Select **EXECUTE**.
 - 4 Start Adjustment with 
 - ➔ **SET REF.** appears briefly.
 - ➔ The last saved value flashes on the display.
 - 5 Select the target adjustment weight. Press  to change a digit (cyclically from left to right); press  to change the blinking digit.
 - 6 Press and hold  to confirm and execute **ADJ.CF**.
 - ➔ The required adjustment weight value flashes in the display. This could take some time.
 - 7 Place required adjustment weight in center of pan.
 - 8 Remove adjustment weight when zero is flashing.
 - 9 Wait until **ADJ.DONE** briefly appears.
 - ➔ The adjusting is finished when the message **ADJ.DONE** appears briefly on the display. The balance returns to the last active application and is ready for operation.
 - ➔ If the error message **WRONG ADJUSTMENT WEIGHT** appears, the weight is not within the allowed value range and could not be accepted. **ADJ.CF** could not be executed.



Note

Storing the adjustment is not required.

Deactivate customer fine adjustment

- 1 Press and hold **CAL** until **ADJUST** appears.
- 2 Select **ADJ.CF** by pressing 
 - ➔ **ADJ.CF** appears on the display.
- 3 Select **RESET**.
- 4 Start **RESET** by pressing 
 - ➔ **NO?** appears.
- 5 Select **YES?** and confirm with 
 - ➔ The adjusting is finished when the message **ADJ.DONE** appears briefly on the display. The balance returns to the last active application and is ready for operation with initial adjustment.

4.9 Performing a simple weighing



The weighing application allows you to perform simple weighings and how you can accelerate the weighing process.

If your balance is not in the weighing mode, press and hold the $\Delta\Delta$ key down until **WEIGH** appears in the display. Release the key. Your balance is in the weighing mode and set to zero.

- 1 Press $\rightarrow 0/T \leftarrow$ to zero the balance.
- 2 Place the sample on the weighing pan.
- 3 Wait until the instability detector \circ disappears.
- 4 Read the result.

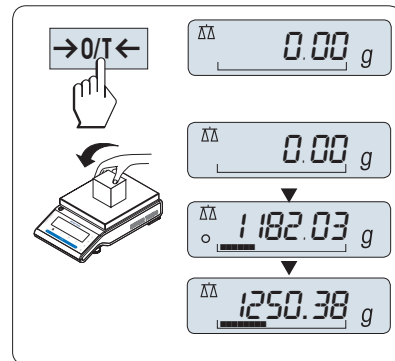

Zeroing

Use the $\rightarrow 0/T \leftarrow$ zeroing key before you start with a weighing.

- 1 Unload the balance.
- 2 Press $\rightarrow 0/T \leftarrow$ to zero the balance.
 - ➔ All weight values are measured in relation to this zero point.

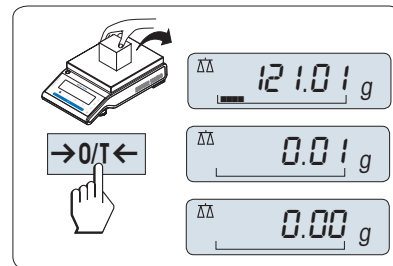

Taring

If you are working with a weighing container, first set the balance to zero.

- 1 Place empty container on the weighing pan.
➔ The weight is displayed.
- 2 Press **→0/T←** to set the balance to zero.
➔ **0.00 g** appears in the display.
- 3 Place weighing sample into the weighing container.
➔ The result appears in the display.

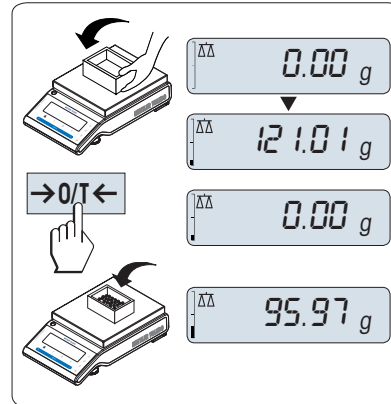

Switching weight units

The  key can be used at any time to toggle between weight unit **UNIT 1**, **RECALL** value (if selected) and weight unit **UNIT 2** (if different from weight unit 1) and the application unit (if any).

- Press  to set weight unit or recall value.

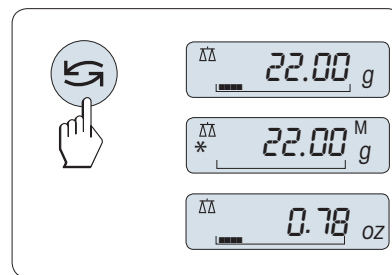

Recall / recall weight value

Recall stores stable weights with an absolute display value bigger than 10d.

- Function **RECALL** is in the menu activated.
- 1 Load weighing sample.
➔ The display shows weight value and stores stable value.
 - 2 Remove weighing sample.
➔ The display shows zero.
 - 3 Press .
➔ The display shows last stored stable weight value for 5 seconds together with asterisk (*) and memory (M) symbols. After 5 seconds the display goes back to zero. This can be repeated unlimited times.

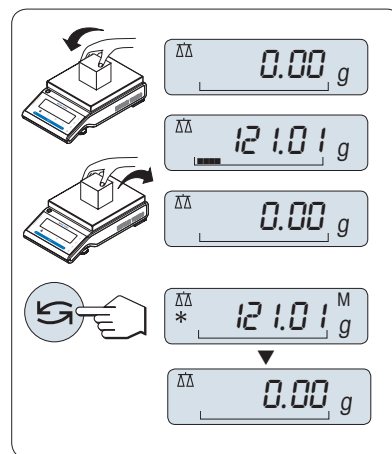

Delete last weight value

As soon a new stable weight value is displayed, the old recall value becomes replaced by the new weight value.

- Press **→0/T←**.
➔ The recall value is set to 0.

If the power is switched off, the recall value is lost. The recall value can not be printed.

Weighing with the weighing-in aid

The weighing-in aid is a dynamic graphic indicator which shows the used amount of the total weighing range. You can thus recognize at a glance when the load on the balance approaches the maximum load.

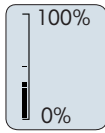

Print / transmit data

Press the  key to transmit the weighing results over the interface, e.g., to a printer or a computer.

Switching off

- Press and hold the  key until **STANDBY** appears on the display. Release the key.
- ➔ **MT.GREEN** appears on the display.
- After switching on from standby mode, your balance needs no warm-up time and is immediately ready for weighing.
- To completely switch off the balance, disconnect it from the power supply.

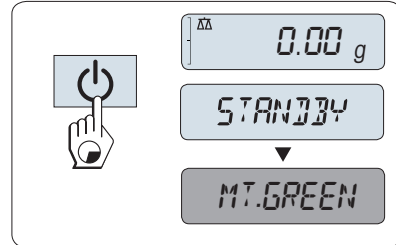

Legal-for-trade

Standby mode is not possible with approved balances (only available in selected countries).

4.10 Transporting the balance



CAUTION

Injury due to breaking glass

Careless handling with the glass components can lead to breakage of glass and damage cuttings.

- 1 Do not lift the instrument by the glass draft shield.
- 2 Always proceed focused and with care.

- 1 Press and hold the  key.
- 2 Disconnect the balance from the power supply.
- 3 Disconnect all interface cables.

4.10.1 Transporting over short distances

To move the balance over a short distance to a new location, follow the instructions below.

- 1 Hold the balance with both hands as shown.
- 2 Carefully lift the balance and carry it to its new location.

If you wish to put the balance into operation, proceed as follows:

- 1 Connect in reverse order.
- 2 Level the balance.
- 3 Perform an internal adjustment.

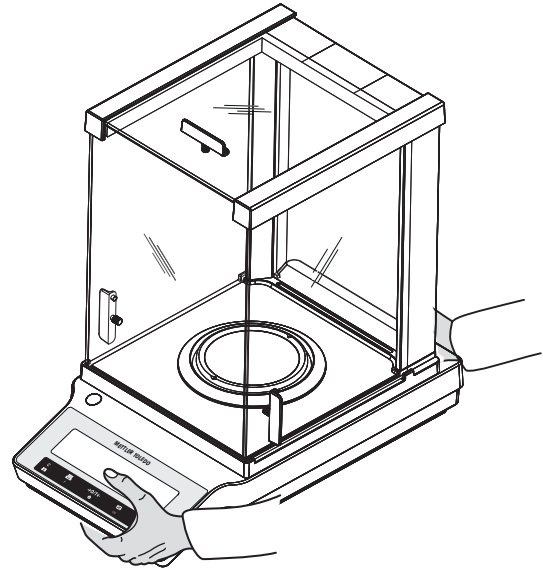

4.10.2 Transporting over long distances

To transport the balance over long distances, always use the original packaging.

4.10.3 Packaging and storage

Packing

Store all parts of the packaging in a safe place. The elements of the original packaging are developed specifically for the balance and its components to ensure maximum protection during transportation or storing.

Storing

Store the balance under following conditions:

- Indoor and in the original packaging.
- According to the environmental condition, see "Technical data".
- When storing for longer than two days, the backup battery may be down (date and time get lost).

4.11 Weighing below the balance

Your balance is equipped with a weighing hook for performing weighing operations below the work surface (weighing below the balance).



NOTICE

Damage to balance

Do not place the balance on the pan support location bolt.

- 1 Press and hold the  key.
- 2 Disconnect the balance from the power supply.
- 3 Disconnect all interface cables.

- 1 Remove weighing pan, pan support and EMC plate if present.
- 2 Turn the balance carefully on its side.
- 3 Remove the cap (keep it for later use). The hanger is now accessible.
- 4 Turn the balance to its normal position and simply reinstall all components in the reverse order.

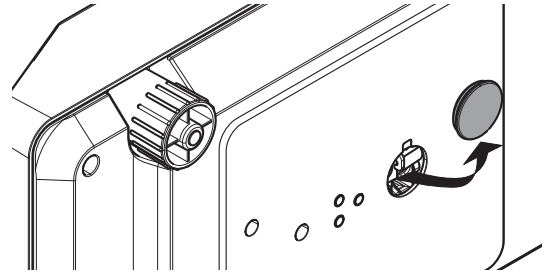

5 The Menu

5.1 What is in the menu ?

The menu allows you to match your balance to your specific weighing needs. In the menu you can change the settings of your balance and activate functions. The main menu has 4 different menus and these contains different topics, each of which allows you various selection possibilities.

For menu **PROTECT** see [Main menu ▶ Page 31].

Menu BASIC

Topic	Description
DATE	Setting the current date.
TIME	Setting the current time.
1/10 D	Setting display increment (1/10d function)
UNIT 1	Specification of the 1 st weight unit in which the balance should show the result.
UNIT 2	Specification of the 2 nd weight unit in which the balance should show the result.
SET ID	Setting an identification.
PRT.MENU	Printing the settings.
RESET	Call up of the factory settings.

Menu ADVANCE.

Topic	Description
ENVIRON.	Matching the balance to the ambient conditions.
ADJ.LOCK	Switching the adjustment function on or off.
DATE.FRM	Setting the date format.
TIME.FRM	Preselection of the time format.
RECALL	Switching the application "Recall" for storing stable weights on or off.
STANDBY	Setting the time after which the balance should be switched off automatically.
B.LIGHT	Switching on or off the display backlight.
A.ZERO	Switching the automatic zero correction (Autozero) on or off.
SRV.ICON	Switching the service reminder (service icon) on or off.
SRV.D.RST	Reset service date and hours (service reminder)

Menu INT.FACE

Topic	Description
RS232	Matching the serial interface RS232C to a peripheral unit.
HEADER	Setting the header for printout of individual values.
SIGN.L	Setting the footer for printout of individual values.
LN.FEED	Setting line feed for printout of individual values.
ZERO.PRT	Setting the auto print function for printing zero.
COM.SET	Setting the data communication format of the serial interface RS232C.
BAUD	Setting the transfer speed of the serial interface RS232C.
BIT.PAR.	Setting the character format (Bit/Parity) of the serial interface RS232C.
STOPBIT	Setting the character format (stop bit) of the serial interface RS232C.
HD.SHK	Setting the transfer protocol (Handshake) of the serial interface RS232C.
RS.TX.E.O.L.	Setting the end of line format of the serial interface RS232C.
RS.CHAR	Setting the char set of the serial interface RS232C.
INTERVL.	Selection of the time interval for the simulated print key press.

5.2 Description of menu topics

In this section you will find information regarding the individual menu topics and the available selections.

5.2.1 Main menu

Selecting the submenu.

BASIC	The BASIC menu for simple weighing is displayed.
ADVANCE.	The ADVANCE. menu for further weighing settings is displayed.
INT.FACE	The menu INT.FACE for all interface parameter settings for peripheral devices e.g. printer is displayed.
PROTECT	The menu PROTECT for protection of the balance configurations against unintended manipulation.

5.2.2 Basic menu

DATE – Date

Setting the current date according to date format.



Note

A reset of the balance will not change this setting.

TIME – Time

Setting the current time according to time format

+1H	Set the current time forwards by 1 hour (to adjust summer or winter time). (Factory setting)
-1H	Set the current time backwards by 1 hour (to adjust summer or winter time).
SET TIME	Enter the current time.



Note

A reset of the balance will not change this setting.

1/10 D – Display increment 1/10 d

This menu topic allows you to reduce the readability of the display.

Legal-for-trade

This menu topic is not available with models which are approved and e=d.

OFF	1/10 D display increment is switched off (full resolution) (Factory setting)
ON	1/10 D switched on (low resolution)



Note

A reset of the balance will not change this setting.

UNIT 1 – Weight unit 1

The balance can operate with the following units (country and model specific).

Legal-for-trade

- Only those weight units allowed by the appropriate national legislation are selectable.
- With approved balances, this menu topic has a fixed setting and cannot be changed.

Units:

g	Gram	dwt	Pennyweight
kg	Kilogram	mom	Momme
mg	Milligram	msg	Mesghal
ct	Carat	tlh	Tael Hong Kong
lb	Pound	tls	Tael Singapore
oz	Ounce (avdp)	tlt	Tael Taiwan
ozt	Ounce (troy)	tola	Tola
GN	Grain	baht	Baht

UNIT 2 – Weight unit 2

If it is required to show the weighing results in weighing mode in an additional unit, the desired second weight unit can be selected in this menu topic (country and model specific). Units see **UNIT 1**.

Legal-for-trade

Only those weight units allowed by the appropriate national legislation are selectable.

SET ID – Set identification

This menu topic allows you to set your own desired identification to the balance for the convenience of asset management or other purposes. The ID can be printed with other balance information. One ID can be set and max 7 alphanumeric characters are possible (blank, 0...9, A...Z).

SET ID

Set identification

The setting starts from left to right and the display prompts the configurable position by flashing corresponding place.

- **SET ID** is selected.

- 1 Search through (blank, 0...9, A...Z) by pressing
- 2 After selecting the character, press to confirm and move to the next place. To store press and hold .



Note

A reset of the balance will not change this setting.

PRT.MENU – Print menu

This menu topic allows you to execute a printout of the menu settings if a printer is connected. This topic is only visible if **PRINTER** mode is selected.

- **PRT.MENU** appears on the display and a printer is properly connected.
- To execute a printout press .

RESET – Reset balance settings

This menu topic allows you to call-up the factory settings.

To toggle between **YES?** and **NO?** press .



Note

A reset of the balance will not change **DATE**, **TIME**, **1/10 D**, and **SET ID** settings.

5.2.3 Advanced menu

ENVIRON. – Environment settings

This setting can be used to match your balance to the ambient conditions.

STD.	Setting for an average working environment subject to moderate variations in the ambient conditions. (Factory setting)
UNSTAB.	Setting for a working environment where the conditions are continuously changing.
STABLE	Setting for a working environment which is practically free from drafts and vibrations.

ADJ.LOCK – Adjustment lock

Under this menu topic you can lock function of the **CAL** key.

OFF	The adjustment lock is switched off . The adjustment function is on. The CAL key is active. (Factory setting)
ON	The adjustment lock is switched on . The adjustment function is off. The CAL key has no function.

DATE.FRM – Date format

This menu topic allows you to preselect the date format.

The following date formats are available:

	Display examples	Printing examples
DD.MM.Y	01.02.09	01.02.2009
MM/DD/Y	02/01/09	02/01/2009
Y-MM-DD	09-02-01	2009-02-01
D.MMM Y	1.FEB.09	1.FEB 2009
MMM D Y	FEB.1.09	FEB 1 2009

Factory setting: DD.MM.Y

TIME.FRM – Time format

This menu topic allows you to preselect the time format.

The following date formats are available:

	Display examples
24:MM	15:04
12:MM	3:04 PM
24.MM	15.04
12.MM	3.04 PM

Factory setting: 24:MM

RECALL – Recall

This menu topic allows you to switch the **RECALL** function on or off. When it is switched on recall stores the last stable weight if the absolute display value was bigger than 10d.

OFF	RECALL switched off. (Factory setting)
ON	RECALL switched on.

The recall value is displayed with an asterisk and cannot be printed.

STANDBY – Automatic standby

If the automatic standby function is activated, the balance automatically switches itself after a pre selected time of inactivity into the energy saver mode **STANDBY** (e.g., with no key being pressed and no changes of weight occurring).

A.OFF	Automatic standby deactivated.
A.ON	Automatic standby activated (Factory setting).
60	Time in minutes of inactivity for activating standby function. Setting range: 2...720 minutes.

B.LIGHT – Backlight

Under this menu topic, the display backlight can be switched off or on.

B.L. ON	Backlight is always on . (Factory setting)
B.L. OFF	Backlight is always off .

A.ZERO – Automatic zero setting

This menu topic allows you to switch the automatic zero setting on or off.



ON	A.ZERO switched on (Factory setting) . The automatic zero setting continuously corrects possible variations in the zero point that might be caused through small amounts of contamination on the weighing pan.
OFF	A.ZERO switched off . The zero point is not automatically corrected. This setting is advantageous for special applications, e.g., evaporation measurements.

Legal-for-trade

With approved balances, this setting is not available in selected countries.

SRV.ICON – Service reminder

This menu topic allows you to switch the service reminder  on or off.

ON	Service reminder  switched on . You will be informed to call service for recalibration. This will be indicated by the flashing service icon:  . (Factory setting)
OFF	Service reminder  switched off .

SRV.D.RST – Service date reset

This menu topic allows you to reset service date.



Note











This menu topic is only available if **SRV.ICON** setting **ON** was selected.

To toggle between **YES?** and **NO?** press .

5.2.4 Interface menu

RS232 – RS232C interface

This menu topic allows you to select the peripheral device connected to the RS232C interface and to specify how the data is transmitted.

PRINTER	Connection to a printer. (Factory setting) Only one printer possible.  Refer to your printer documentation for recommended printer settings.
PRT.STAB	If the  key is pressed, the next stable weight value will be printed. (Factory setting)
PRT.AUTO	Every stable weight value will be printed, without pressing the  key.
PRT.ALL	If the  key is pressed, the weight value will be printed regardless of stability.
PC-DIR.	Connection to a PC: the balance can send data (as a Keyboard) to the PC used for PC applications, e.g., Excel. <ul style="list-style-type: none">• The balance sends the weight value without the unit to the PC.• Not available on Win7.
PRT.STAB	If the  key is pressed, the next stable weight value will be sent followed by an enter. (Factory setting)
PRT.AUTO	Every stable weight value will be sent followed by an enter, without pressing the  key.
PRT.ALL	If the  key is pressed, the weight value will be sent followed by an enter regardless of stability.
HOST	Connection to a PC, barcode reader etc.: the balance can send data to the PC and receive commands or data from the PC. The balance sends the complete MT-SICS answer to the PC, see chapter "MT-SICS interface commands and functions".
SND.OFF	Send mode switched off. (Factory setting)
SND.STB	If the  key is pressed, the next stable weight value will be sent.
SND.CONT	All weight value updates will be sent regardless of stability, without pressing the  key.
SND.AUTO	Every stable weight value will be sent, without pressing the  key.
SND.ALL	If the  key is pressed, the weight value will be sent regardless of stability.
2.DISP	Connection of an optional auxiliary display unit. The transmission parameters cannot be selected. Settings are automatically set.

HEADER – Options for the printout header of individual values

This menu topic allows you to specify the information that is to be printed at the top of the printout for every individual weighing results (after pressing .



Note

This menu topic is only available if **PRINTER** setting was selected.

NO	The header is not be printed. (Factory setting)
-----------	--

DAT/TIM	Date and time are printed.
D/T/BAL	Date, time and balance information (Balance type, SNR, Balance ID) are printed. Balance ID only if set.

SINGLE – Options for printing out the result of individual values

This menu topic allows you to specify the information that is to be printed for every individual weighing result (after pressing .



Note

This menu topic is only available if **PRINTER** setting was selected.

NET	The value of the net weight from the current weighing is printed. (Factory setting)
G/T/N	The values of the gross weight, the tare weight and the net weight are printed (only possible on approved balances).

SIGN.L – Options for the printout footer for signature line of individual values

This menu topic allows you to set a footer for signature at the bottom of the printout for every individual weighing result (after pressing .



Note

This menu topic is only available if **PRINTER** setting was selected.

OFF	The signature footer is not be printed. (Factory setting)
ON	The signature footer is printed.

LN.FEED – Options for complete the printout of individual values

This menu topic allows you to specify the number of blank lines to complete the printout for every individual weighing result (after pressing .



Note

This menu topic is only available if **PRINTER** setting was selected.

0	Possible numbers of blank lines: 0 to 99. (Factory setting = 0)
----------	--

ZERO.PRT – Options for PRT.AUTO

This menu topic allows you to specify the auto print function **PRT.AUTO** for printing zero **YES** or **NO**.

OFF	Zero is not be printed (Zero +/- 3d). (Factory setting)
ON	Zero is always printed.



Note

This menu topic is only available if **PRT.AUTO** function of the **PRINTER** or **PC-DIR.** was selected.

COM.SET – Options for the data communication format (RS232C) (HOST)

This menu topic allows you to set the data format depending on which peripheral device is connected.



Note

This menu topic is only available if **HOST** setting was selected.

MT-SICS	The MT-SICS data transfer formats is used. (Factory setting) For more information, see "MT-SICS interface commands and functions".
SART	The following Sartorius commands are supported: K Ambient conditions: very stable L Ambient conditions: stable

M	Ambient conditions: unstable
N	Ambient conditions: very unstable
O	Block keys
P	Print key (print, auto print; activate or block)
R	Unblock keys
S	Restart/self-test
T	Tare key
W	Calibration/adjustment ^{*)}
Z	Internal adjustment ^{**)}
f1_	Function key (CAL)
s3_	C key
x0_	Perform internal adjustment ^{**)}
x1_	Print balance/scale model
x2_	Print weighing cell serial number
x3_	Print software version

^{*)} May be inaccessible on verified balances/scales

^{**)} Only on models with built-in motorized adjustment weight

Functionality mapping

HOST settings:	Sartorius printer settings:
SND.OFF	not applicable
SND.STB	manually print with stability
SND.ALL	manually print without stability
SND.CONT	automatically print without stability
SND.AUTO	similar applicable to automatically print when load is changed

BAUD – Baud rate RS232C

This menu topic allows you to match the data transmission to different serial RS232C receivers. The baud rate (data transfer rate) determines the speed of transmission via the serial interface. For problem-free data transmission the sending and receiving devices must be set at the same value.

The following settings are available:

600 bd, 1200 bd, 2400 bd, 4800 bd, **9600 bd (Factory setting)**, 19200 and 38400 bd.



Note

- Not visible for 2nd display.
- Each device has separate settings.

BIT.PAR. – Bit/Parity RS232C

This menu topic allows you to set the character format for the attached RS232C serial peripheral device.

8/NO	8 data bits/no parity (Factory setting)
7/NO	7 data bits/no parity
7/MARK	7 data bits/mark parity
7/SPACE	7 data bits/space parity
7/EVEN	7 data bits/even parity
7/ODD	7 data bits/odd parity

**Note**

- Not visible for 2nd display.
- Each device has separate settings.

STOPBIT – Stop bits RS232C

This menu topic allows you to set the stop bits of the transmitted data to different RS232C serial receivers.

1 BIT	1 Stop bit (Factory setting)
2 BITS	2 Stop bits

HD.SHK – Handshake RS232C

This menu topic allows you to match the data transmission to different RS232C serial receivers.

XON.XOFF	Software handshake (XON/XOFF) (Factory setting)
RTS.CTS	Hardware handshake (RTS/CTS)
OFF	No handshake

**Note**

- Not visible for 2nd display.
- Each device has separate settings.

RS.TX.E.O.L. – End of line RS232C

This menu topic allows you to set the end of line character of the outgoing transmitted data to different RS232C serial receivers.

CR LF	Carriage Return followed by Line feed (ASCII-Codes 013 + 010) (Factory setting)
CR	Carriage Return (ASCII-Code 013)
LF	Line feed (ASCII-Code 010)
TAB	Horizontal tab (ASCII-Code 009) (only visible if PC-DIR. is selected)

**Note**

- Not visible for 2nd display.
- Each device has separate settings.

RS.CHAR – Char set RS232C

This menu topic allows you to set the character set of the transmitted data to different RS232C serial receivers.

IBM.DOS	Char set IBM/DOS (Factory setting)
ANSI.WIN	Char set ANSI/WINDOWS

**Note**

- Not visible for 2nd display.
- Each device has separate settings.

INTERVL. – Print key simulation

This menu topic allows you to activate a simulation of the  key. **INTERVL.** simulates pressing the print key every x seconds.

Range:	0 to 65535 seconds
0 sec:	Disables the print key simulation

Factory setting: 0 sec



The executed action is according to the configuration of the print key, see interface setting.

6 Applications

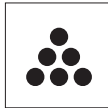
6.1 Application piece counting



The **Piece counting** application allows you to determine the number of pieces put on the weighing pan.

- 1 Press and hold **F** to call-up **APP.LIST**.
- 2 Select application **COUNT** by scrolling with .
- 3 Press  to activate the function.

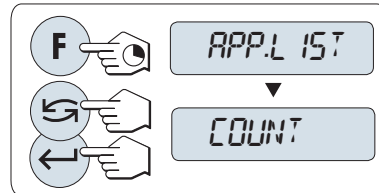





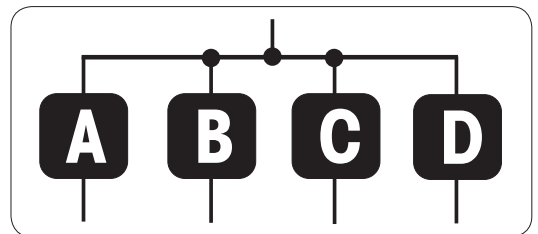

Piece counting first requires the setting of a reference weight, there are 4 possibilities

- **A** Setting the reference **by multiple pieces with fix reference values**.
- **B** Setting the reference **by multiple pieces with variable reference values**.
- **C** Setting the reference **for 1 piece in weighing mode**.
- **D** Setting the reference **for 1 piece in manual mode**.



Setting the reference by multiple pieces with fix reference values



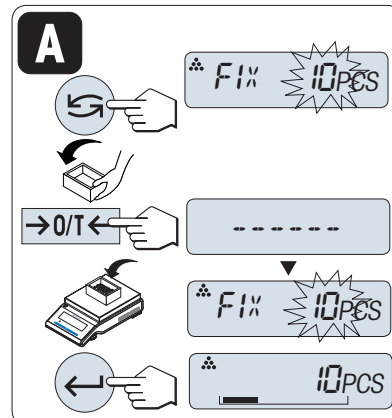



- 1 Select a number of reference pieces by scrolling with . Possible numbers* are 5, 10, 20 and 50.
- 2 Press /0/T/ to zero the balance. If using: place empty container on the weighing pan and press /0/T/ to tare the balance.
- 3 Add the selected number of reference pieces to container.
- 4 Press  to confirm.



Legal-for-trade

* with approved balances in selected countries: min 10.

Setting the reference by multiple pieces with variable reference values



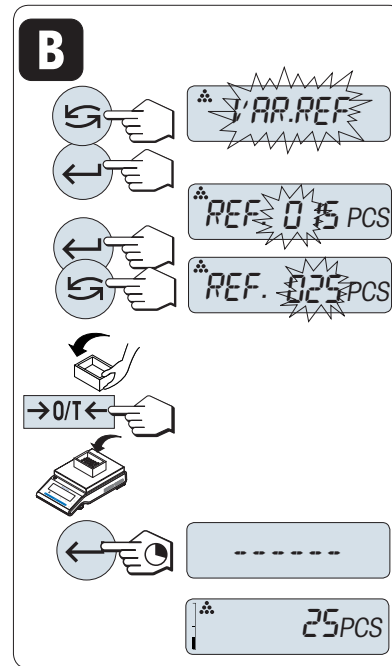

- 1 Select **VAR.REF** by scrolling with .
- 2 Press  to confirm.
- 3 Select the number of reference pieces. Possible numbers* are 1 to 999.
- 4 Press  to select a digit (cyclically from left to right).
➔ The selected digit is blinking.
- 5 Press  to change the digit.
- 6 Press  to zero the balance. If using: place empty container on the weighing pan and press  to tare the balance.
- 7 Add the selected number of reference pieces to container.
- 8 Press and hold  to confirm.



Legal-for-trade

* with approved balances in selected countries: min 10.

Setting the reference for one piece in weighing mode



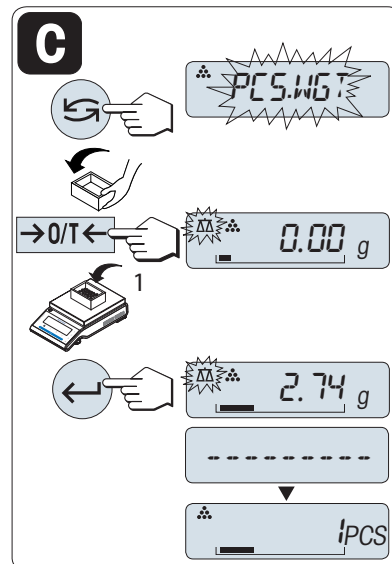

- 1 Select **PCS.WGT** by scrolling with .
- 2 Press  to zero the balance. If using: place empty container on the weighing pan and press  to tare the balance.
- 3 Add one reference piece to container.
➔ The weight of one piece is displayed.
- 4 Press  to confirm.



Legal-for-trade

With approved balances, this setting is not available in selected countries.

Setting the reference for one piece in manual mode

- 1 Select **PCS.WGT** by scrolling with .
- 2 Press  to confirm.
- 3 Enter the final reference one piece weight.
- 4 Press  to select a digit (cyclically from left to right).
➔ The selected digit is blinking.
- 5 Press  to change the digit.
- 6 Press and hold  to confirm.

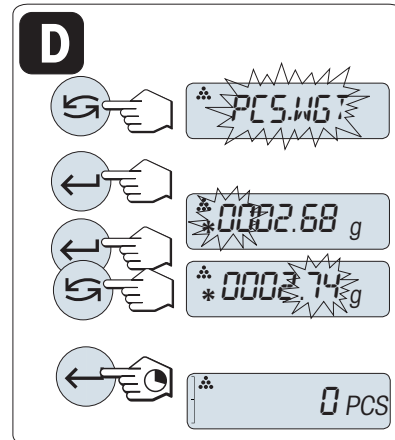

Legal-for-trade

With approved balances, this setting is not available in selected countries.



Note

If without any key press within 60 seconds or by pressing **C**, the balance returns to the previous active application.

On completion of the setting procedure, your balance is ready.

- The **RECALL** value is displayed with an asterisk (*) and icon **M** and can not be printed.
- Take into account minimum values: min. reference weight = 10d (10 digits), min. piece weight* = 1d (1 digit)!
* with approved balances in selected countries: min 3e
- The current reference weight remains stored until the reference setting is changed.

Terminate the application

Press and hold  to terminate the application and to return to the weighing application.

6.2 Application percent weighing



The **Percent weighing** application allows you to check a sample weight as percentage to a reference target weight.

- 1 Press and hold **F** to call-up **APP.LIST**.
- 2 Select application **PERCENT** by scrolling with
- 3 Press to activate the function.

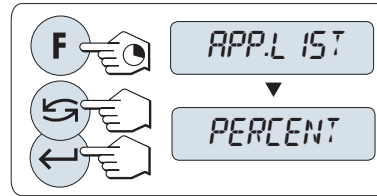

Percent weighing first requires the setting of a reference weight that should corresponds to 100%, there are 2 possibilities

- **A** Setting the reference **in manual mode (enter 100%)**.
- **B** Setting the reference **in weighing mode (weigh 100%)**.

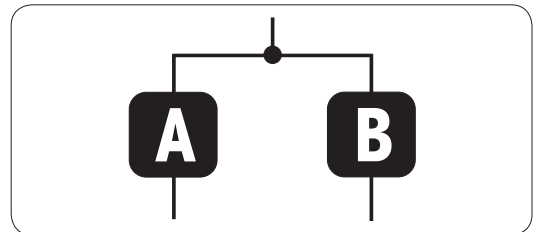

Setting the reference by manual mode (enter 100%)

- 1 Press to activate manual mode.
- 2 Press to select a digit (cyclically from left to right).
→ The selected digit is blinking.
- 3 Press to change the digit.
- 4 Press and hold to confirm.

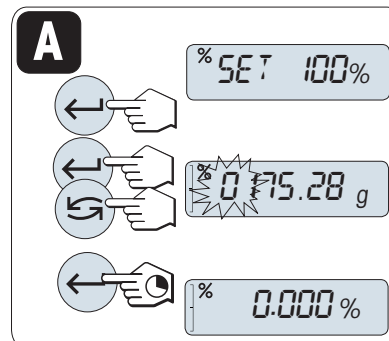

Setting the reference by weighing mode (weigh 100%)

- 1 Press to zero the balance. If using: place empty container on the weighing pan and press to tare the balance.
- 2 Load the reference weight (100%). Reference weight must be at least +/- 10d.
- 3 Press to confirm.

If without any key press within 60 seconds or by pressing **C**, the balance returns to the previous active application.

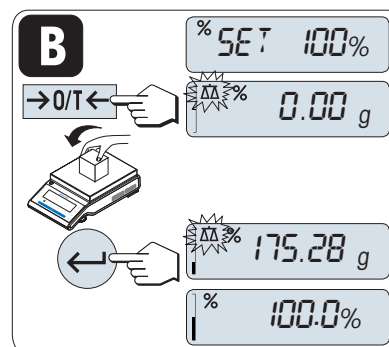

On completion of the setting procedure, your balance is ready.

Switching between percent and weight display

- Press  key at any time to switch the display between percent display, weighing unit **UNIT 1**, **RECALL** value (if activated) and weighing unit **UNIT 2** (if different from **UNIT 1**).

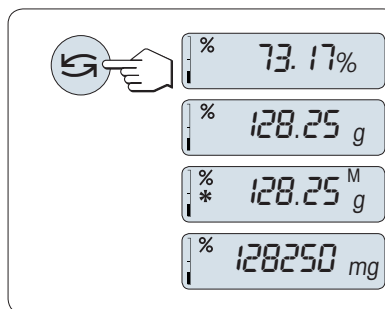

Terminate the application

Press and hold  to terminate the application and to return to the weighing application.

6.3 Application check weighing

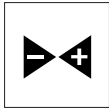

The **Check weighing** application allows you to check the deviation of a sample weight within a tolerance limit to a reference target weight.

- 1 Press and hold **F** to call-up **APP.LIST**.
- 2 Select application **CHECK** by scrolling with .
- 3 Press to activate the function.

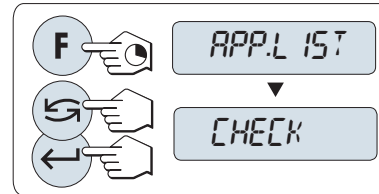

Step 1: Check weighing first requires the setting of a reference weight that should corresponds to the nominal weight, there are 2 possibilities

- **1A** Setting the reference **in manual mode** (enter nominal weight).
- **1B** Setting the reference **in weighing mode** (weigh nominal weight).

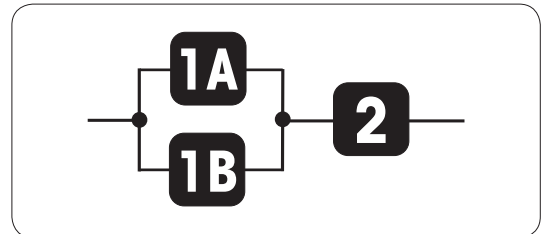

Step 2: Check weighing needs the upper and lower limits

- **2** Setting the **upper and lower limits in percentage**.

Setting the reference by manual mode (enter nominal weight)

- 1 Press to activate manual mode.
- 2 Select the reference target weight.
- 3 Press to select a digit (cyclically from left to right).
→ The selected digit is blinking.
- 4 Press to change the digit.
- 5 Press and hold to confirm.

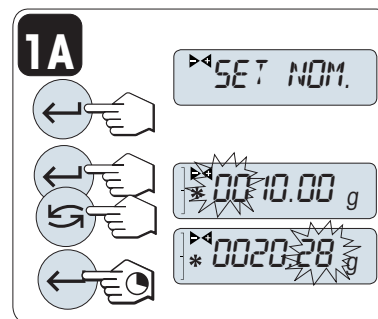

Setting the reference in weighing mode (weigh nominal weight)

- 1 Press **0/T** to zero the balance. If using: place empty container on the weighing pan and press **0/T** to tare the balance.
- 2 Load the nominal weight.
- 3 Press to confirm.

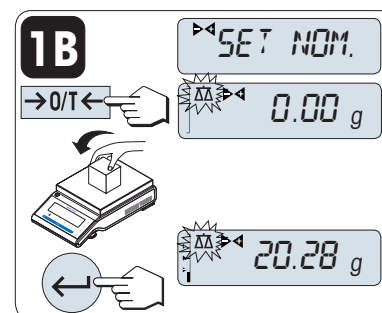

Setting the upper and lower limits (in percentage)

- 1 Press \leftarrow to start setting.
- 2 Press \leftarrow to confirm the default limit of +/- 2.5% or enter the limit value.
- 3 Press \leftarrow to select a digit (cyclically from left to right).
➔ The selected digit is blinking.
- 4 Press \rightarrow to change the digit.
- 5 Press and hold \leftarrow to confirm.

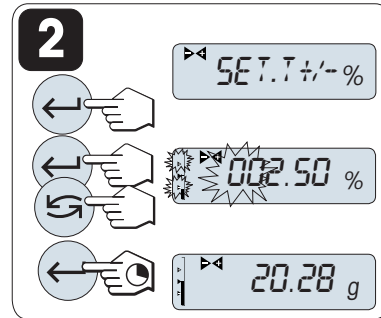

Note

If without any key press within 60 seconds or by pressing **C**, the balance returns to the previous active application.

The nominal weight must be at least 10 digit.

On completion of the setting procedure, your balance is ready.

Weighing-in-aid

The weighing-in-aid helps you quickly determine the position of the sample weight regarding the tolerance.

- **1** Lower limit
- **2** Target weight
- **3** Upper limit

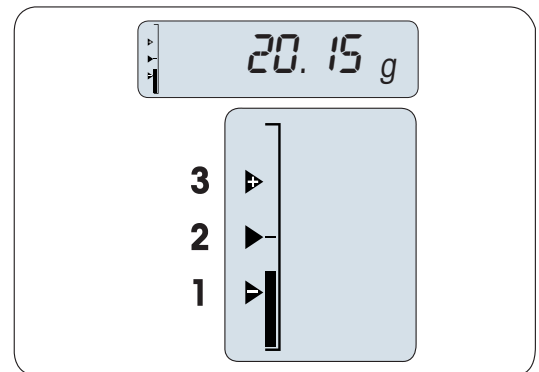



Terminate the application

Press and hold $\overline{\Delta\Delta}$ to terminate the application and to return to the weighing application.

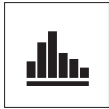
6.4 Application statistics



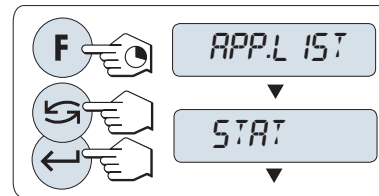

The **Statistics** application allows you to generate statistics of a series of weighing values. 1 to 999 values are possible.

- 1 Press and hold **F** to call-up **APP.LIST**.
- 2 Select application **STAT.** by scrolling with .
- 3 Press  to activate the function.





Memory clear question

If the memory is already cleared (sample counter is 0) the memory clear question will not be displayed.

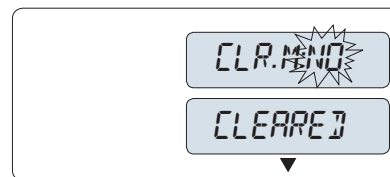
- 1 To continue the last statistics, press  to confirm **CLR.M:NO**.
- 2 For a new statistical evaluation clear the memory. Press  to select **CLR.M:YES** and press  to confirm.



Weighing the first sample weight

- 1 Press  **0**  to zero the balance.
- 2 Load the first sample weight.
- 3 Press .
 - ➔ The display shows the sample count - **1** - and the current weight is stored as sample and the weight is printed out.
- 4 When the sample counter is displayed you may press and hold **C** to undo (drop) this sample.
- 5 Unload the first sample weight.

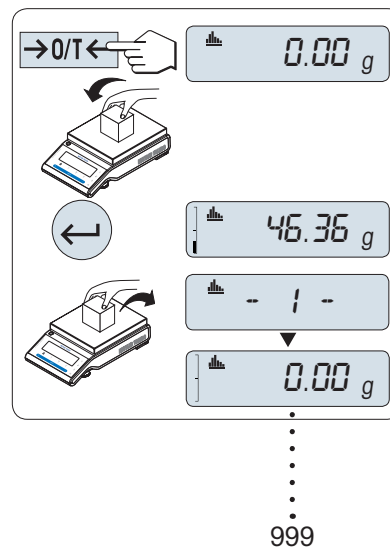

Weighing further sample weights

The same procedure as for the first sample weight.

- 1...999 samples are possible.
- The next value will be accepted if the sample weight is in the range 70% –130% of the current average value. **OUT OF RANGE** will be displayed if the sample is not accepted.

Results



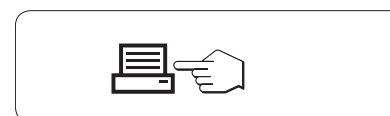











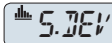

- Press , if the numbers of sample are greater than or equal to 2.
 - ➔ The results are displayed and printed.



Displayed results

- 1 Press \leftarrow to show the next statistical value.
- 2 Press **C** to cancel displaying results and to continue weighing next sample.

0.5 seconds

number of samples	 N	▶	 5	←
average	 x	▶	 50.530 g	←
standard deviation	 S.DEV	▶	 3.961 g	←
relative standard deviation	 S.REL	▶	 7.84 %	←
lowest value (minimum)	 MIN	▶	 46.36 g	←
highest value (maximum)	 MAX	▶	 55.81 g	←
different between the minimum and the maximum	 DIFF	▶	 9.45 g	←
sum of all values	 SUM	▶	 252.65 g	←



Terminate the application

Press and hold $\overline{\Delta\Delta}$ to terminate the application and to return to the weighing application.

6.5 Application totaling



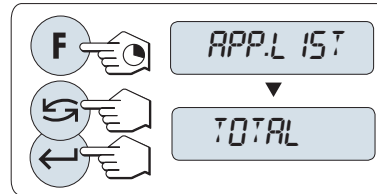

The **TOTALING** application allows you to weigh in different samples to add their weight values and to totalize them. 1 to 999 samples are possible.

- 1 Press and hold **F** to call-up **APP.LIST**.
- 2 Select application **TOTAL** by scrolling with .
- 3 Press  to activate the function.





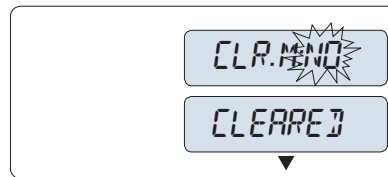

Memory clear question

If the memory is already cleared (sample counter is 0) the memory clear question will not be displayed.

- 1 To continue the totaling evaluation, press  to confirm **CLR.M:NO**.
- 2 For a new totaling evaluation clear the memory. Press  to select **CLR.M:YES** and press  to confirm.



Weighing in the sample weight

- 1 Press  **0/T**  to zero the balance. If using: place empty container on the weighing pan and press  **0/T**  to tare the balance.
- 2 Load the first sample weight.
- 3 Press .
 - ➔ The display shows the sample count - 1 - and the current weight is stored.
- 4 When the sample counter is displayed you may press and hold **C** to undo (drop) this sample.
- 5 Unload the first sample weight.
 - ➔ The display shows zero.

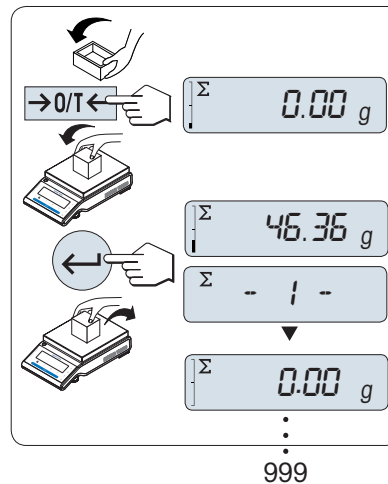

Weighing in further sample weights

The same procedure as for the first sample weight.

- 1...999 samples are possible.

Results

- Press  if the numbers of sample are greater than or equal to 2.
 - ➔ The results are displayed and printed.

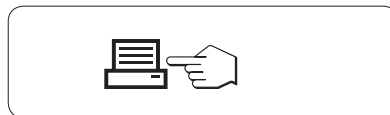

Displayed results

- 1 Press  to show the totalized value.
- 2 Press **C** to cancel.

0.5 seconds

number of samples ΣN \rightarrow $*\Sigma$ 879 \leftarrow

totalized value $\Sigma TOTAL$ \rightarrow $*\Sigma$ 8789.79 g \leftarrow



Terminate the application

Press and hold  to terminate the application and to return to the weighing application.

6.6 Application multiplication factor weighing





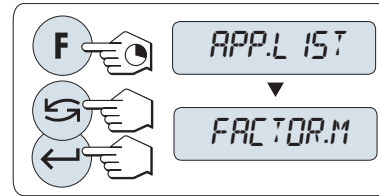

The **Multiplication factor weighing** application allows you to multiply the weight value (in grams) by a predefined factor (result = factor * weight) and have it calculated to a predefined number of decimal places.

- 1 Press and hold **F** to call-up **APP.LIST**.
- 2 Select application **FACTOR.M** by scrolling with .
- 3 Press  to activate the function.



Setting the factor value

Zero for multiplication factor value is outside the allowed range, the error message **FACTOR OUT OF RANGE** will be displayed.



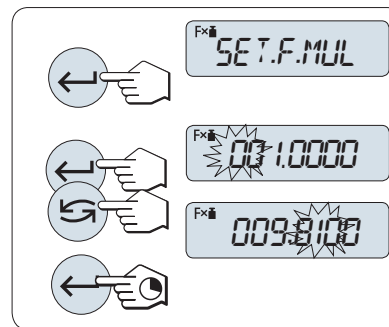

- 1 Press  to execute **SET.F.MUL**.
 - ➔ Either the factor 1 appears as default value or the factor that was saved most recently.
- 2 Press  to select a digit (cyclically from left to right).
 - ➔ The selected digit is blinking.
- 3 Press  to change the digit.
- 4 Press and hold  to confirm (no automatic acceptance).



Setting the step value

SET.STEP appears on the display, and the program changes automatically to allow the display increments to be entered. The smallest possible display increment appears as default value, or the last value that was saved.

The allowed range for the step depends on the factor and the resolution of the balance. If it is outside the allowed range, the error message **STEP OUT OF RANGE** will be displayed.

- 1 Press  to execute **SET.STEP**.
- 2 Press  to select a digit (cyclically from left to right).
 - ➔ The selected digit is blinking.
- 3 Press  to change the digit.
- 4 Press and hold  to confirm (no automatic acceptance).

If without any key press within 60 seconds or by pressing **C**, the balance returns to the previous active application.

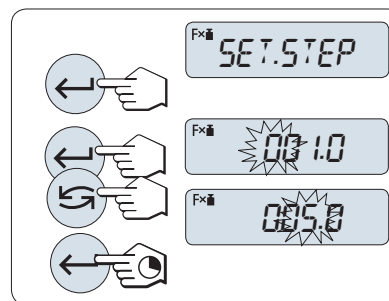

On completion of the setting procedure, your balance is ready.

Weighing procedure

- 1 Press $\rightarrow 0/T \leftarrow$ to zero the balance.
- 2 Load sample weight.
- 3 Read the result.
 - ➔ The appropriate calculation is then made using the weight of sample and the selected factor, the result being displayed with the selected display step. No units are displayed.
- 4 Unload sample weight.

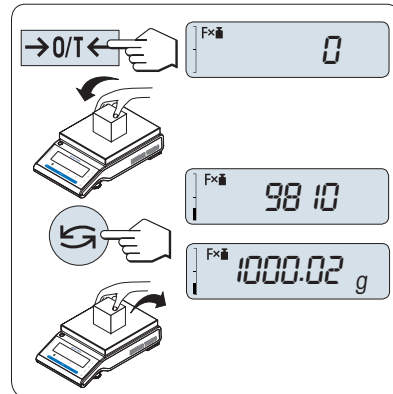

Toggling between displaying the calculated value and the measured weight

- Press \leftarrow key at any time to switch the display between percent display, weighing unit **UNIT 1**, **RECALL** value (if activated) and weighing unit **UNIT 2** (if different from **UNIT 1**).



Terminate the application

Press and hold $\Delta \nabla$ to terminate the application and to return to the weighing application.

6.7 Application division factor weighing





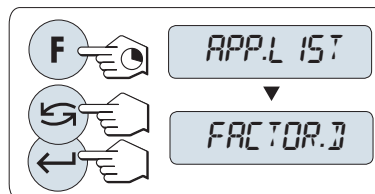

The **Division factor weighing** divide a predefined factor by the weight value (in grams) (result = factor / weight) and have it rounded to a predefined number of decimal places.

- 1 Press and hold **F** to call-up **APP.LIST**.
- 2 Select application **FACTOR.D** by scrolling with .
- 3 Press  to activate the function.



Setting the factor value

Zero for division factor value is outside the allowed range, the error message **FACTOR OUT OF RANGE** will be displayed.



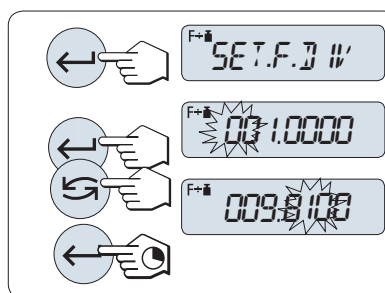

- 1 Press  to execute **SET.F.DIV**.
 - ➔ Either the factor 1 appears as default value or the factor that was saved most recently.
- 2 Press  to select a digit (cyclically from left to right).
 - ➔ The selected digit is blinking.
- 3 Press  to change the digit.
- 4 Press and hold  to confirm (no automatic acceptance).



Setting the step value

SET.STEP appears on the display, and the program changes automatically to allow the display increments to be entered. The smallest possible display increment appears as default value, or the last value that was saved.

The allowed range for the step depends on the factor and the resolution of the balance. If it is outside the allowed range, the error message **STEP OUT OF RANGE** will be displayed.

- 1 Press  to execute **SET.STEP**.
- 2 Press  to select a digit (cyclically from left to right).
 - ➔ The selected digit is blinking.
- 3 Press  to change the digit.
- 4 Press and hold  to confirm (no automatic acceptance).

If without any key press within 60 seconds or by pressing **C**, the balance returns to the previous active application.

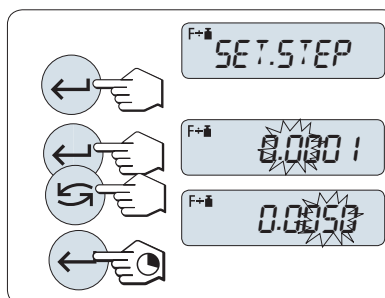

On completion of the setting procedure, your balance is ready.

Weighing procedure

- 1 Press $\rightarrow 0/T \leftarrow$ to zero the balance.
- 2 Load sample weight.
- 3 Read the result.
 - ➔ The appropriate calculation is then made using the weight of sample and the selected factor, the result being displayed with the selected display step. No units are displayed.
- 4 Unload sample weight.

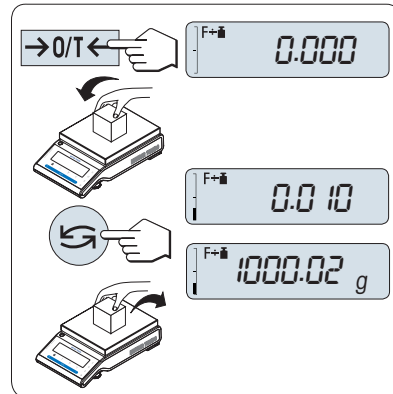

Toggling between displaying the calculated value and the measured weight

- Press $\rightarrow \leftarrow$ key at any time to switch the display between percent display, weighing unit **UNIT 1**, **RECALL** value (if activated) and weighing unit **UNIT 2** (if different from **UNIT 1**).

Terminate the application

Press and hold $\Delta \nabla$ to terminate the application and to return to the weighing application.

6.8 Application density



The **DENSITY** application allows you to determine the density of solid bodies and liquids. Determination of the density uses **Archimedes' principle** according to which a body immersed in a fluid undergoes an apparent loss in weight which is equal to the weight of the fluid it displaces.



To determine the density of solid bodies, we recommend you to work with the optional density kit which contains all the attachments and aids needed for convenient and precise density determination. To determine the density of liquids, you additionally need a sinker which you can also obtain from your METTLER TOLEDO dealer.

Note for performing of density determinations

- You can also use the weighing hook for weighing below the balance which belongs to your balance.
- If a METTLER TOLEDO printer is attached to your balance, the settings will be automatically recorded.



We recommend you to consult the manual enclosed with the density kit.

- 1 Press and hold **F** to call-up **APP.LIST**.
- 2 Select application **DENSITY** by scrolling with .
- 3 Press  to activate the function.

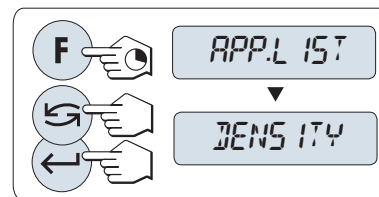

Setting the method for density determination

- 1 Select:
SOLID, the function for the density determination of solids, or
LIQUID, the function for the density determination of liquids with a sinker.
- 2 Press  to confirm.

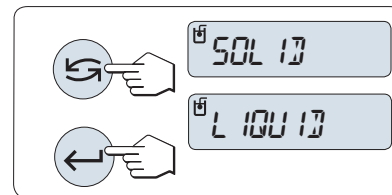



Terminate the application

Press and hold  to terminate the application and to return to the weighing application.



6.8.1 Density determination of solids

Setting the parameter of the auxiliary liquid

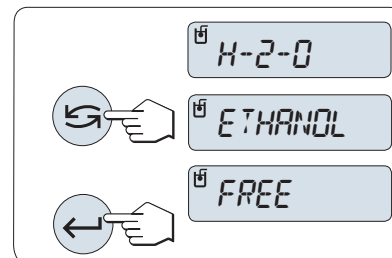
- Method **SOLID** is set.
- 1 Select the auxiliary liquid by scrolling with : **H-2-O** for distilled water, **ETHANOL** or **FREE** for a freely definable auxiliary liquid.
 - 2 Press  to confirm.



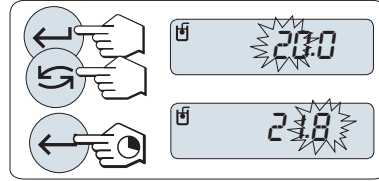

If you have selected water or ethanol as the auxiliary liquid

- 1 Enter the current temperature of the auxiliary liquid (read off on thermometer).
- 2 Set the value in °C. The temperature ranges from 10 °C to 30.9 °C.
- 3 Press  to select a digit (cyclically from left to right).
➔ The selected digit is blinking.
- 4 Press  to change the digit.
- 5 Press and hold  to confirm.



The densities of distilled water and ethanol in the range 10°C to 30.9°C are stored in the balance.

If you have selected a freely definable auxiliary liquid

- 1 Enter the density of the auxiliary liquid at the current temperature (read off on thermometer).
- 2 Press  to select a digit (cyclically from left to right).
➔ The selected digit is blinking.
- 3 To change the digit, press .
- 4 Press and hold  to confirm.

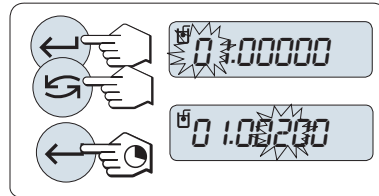

If without any key press within 60 seconds or by pressing **C**, the balance returns to the previous active application.

On completion of the setting procedure, your balance is ready.

Taring the balance is possible at any time.

The balance prompts you: **PRESS ENTER TO START.**

- Press  to start.
- ➔ Tare/Zero is executed.

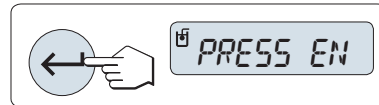

The balance prompts you to weigh the solid in air **WEIGH IN AIR.**

- 1 Load the solid.
- 2 Press  to initiate the measurement.



The balance prompts you to weigh the solid in the auxiliary liquid **WEIGH IN LIQUID.**

- 1 Load the solid.
- 2 Press  to initiate the measurement.
➔ The balance now shows the determined density of the solid in g/cm³.



- This result has already been corrected for the air buoyancy. The buoyancy caused by the two immersed wires (ø 0.6 mm) can be neglected.
- Press **C** the balance returns to **PRESS ENTER TO START.**

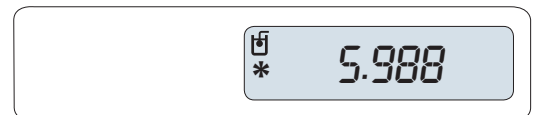

Result

- Press .
- ➔ The result will be printed.

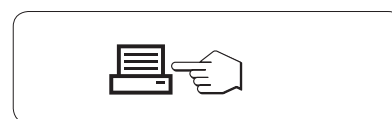

6.8.2 Density determination of liquids

Setting the displacement volume of your sinker

- Method **LIQUID** is set.
- 1 Press to confirm the default value of 10.0 cm³ or change it if needed.
- 2 Press to select a digit.
 - ➔ The selected digit is blinking.
- 3 Press to change the digit.
- 4 Press and hold to confirm.

If without any key press within 60 seconds or by pressing **C**, the balance returns to the previous active application.

On completion of the setting procedure, your balance is ready.

Taring the balance is possible at any time.

The balance prompts you: **PRESS ENTER TO START.**

- Press to start.

The balance prompts you to weigh the sinker in air **WEIGH IN AIR.**

- 1 Position the sinker.
- 2 Press to initiate the measurement.

The balance prompts you to weigh the sinker in the liquid **WEIGH IN LIQUID.**

- 1 Pour the liquid into the beaker. Make sure that the sinker is immersed by at least 1 cm in the liquid, and that there are no air bubbles in the container.
 - 2 Press to initiate the measurement.
 - ➔ The balance now shows the determined density of the liquid at the current temperature (read off on the thermometer).
- This result has already been corrected for the air buoyancy. The buoyancy caused by the immersed wire (∅ 0.2 mm) of the sinker can be neglected.
- Press **C** the balance returns to **PRESS ENTER TO START.**

Result

- Press .
- ➔ The result will be printed.

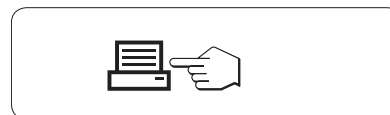
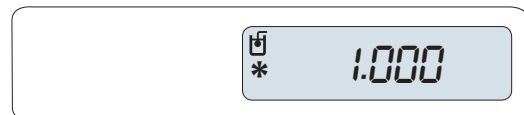
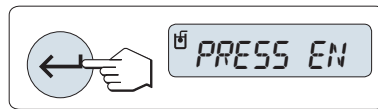
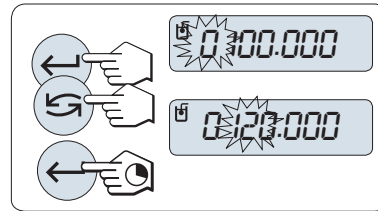

6.8.3 Formulae used to calculate density

The **DENSITY** application is based on the formulae listed below.

Formulae for determining the density of solids with compensation for air density

$$\rho = \frac{A}{A-B} (\rho_0 - \rho_L) + \rho_L$$

$$V = \alpha \frac{A - B}{\rho_0 - \rho_L}$$

- ρ = Density of the sample
 A = Weight of the sample in air
 B = Weight of the sample in the auxiliary liquid
 V = Volume of the sample
 ρ_0 = Density of the auxiliary liquid
 ρ_L = Density of air (0.0012 g/cm³)
 α = Weight correction factor (0.99985), to take the atmospheric buoyancy of the adjustment weight into account

Formula for determining the density of liquids with compensation for air density

$$\rho = \alpha \frac{P}{V} + \rho_L$$

- ρ = Density of the liquid
 P = Weight of the displaced liquid
 V = Volume of the sinker
 ρ_L = Density of air (0.0012 g/cm³)
 α = Weight correction factor (0.99985), to take the atmospheric buoyancy of the adjustment weight into account

Density of H₂O given in g/cm³

According to the "American Institute of Physics Handbook".

T/°C	0.0	0.1	0.2	0.3	0.4	0.5	0.6	0.7	0.8	0.9
10.	0.99973	0.99972	0.99971	0.99970	0.99969	0.99968	0.99967	0.99966	0.99965	0.99964
11.	0.99963	0.99962	0.99961	0.99960	0.99959	0.99958	0.99957	0.99956	0.99955	0.99954
12.	0.99953	0.99951	0.99950	0.99949	0.99948	0.99947	0.99946	0.99944	0.99943	0.99942
13.	0.99941	0.99939	0.99938	0.99937	0.99935	0.99934	0.99933	0.99931	0.99930	0.99929
14.	0.99927	0.99926	0.99924	0.99923	0.99922	0.99920	0.99919	0.99917	0.99916	0.99914
15.	0.99913	0.99911	0.99910	0.99908	0.99907	0.99905	0.99904	0.99902	0.99900	0.99899
16.	0.99897	0.99896	0.99894	0.99892	0.99891	0.99889	0.99887	0.99885	0.99884	0.99882
17.	0.99880	0.99879	0.99877	0.99875	0.99873	0.99871	0.99870	0.99868	0.99866	0.99864
18.	0.99862	0.99860	0.99859	0.99857	0.99855	0.99853	0.99851	0.99849	0.99847	0.99845
19.	0.99843	0.99841	0.99839	0.99837	0.99835	0.99833	0.99831	0.99829	0.99827	0.99825
20.	0.99823	0.99821	0.99819	0.99817	0.99815	0.99813	0.99811	0.99808	0.99806	0.99804
21.	0.99802	0.99800	0.99798	0.99795	0.99793	0.99791	0.99789	0.99786	0.99784	0.99782
22.	0.99780	0.99777	0.99775	0.99773	0.99771	0.99768	0.99766	0.99764	0.99761	0.99759
23.	0.99756	0.99754	0.99752	0.99749	0.99747	0.99744	0.99742	0.99740	0.99737	0.99735
24.	0.99732	0.99730	0.99727	0.99725	0.99722	0.99720	0.99717	0.99715	0.99712	0.99710
25.	0.99707	0.99704	0.99702	0.99699	0.99697	0.99694	0.99691	0.99689	0.99686	0.99684
26.	0.99681	0.99678	0.99676	0.99673	0.99670	0.99668	0.99665	0.99662	0.99659	0.99657
27.	0.99654	0.99651	0.99648	0.99646	0.99643	0.99640	0.99637	0.99634	0.99632	0.99629
28.	0.99626	0.99623	0.99620	0.99617	0.99614	0.99612	0.99609	0.99606	0.99603	0.99600
29.	0.99597	0.99594	0.99591	0.99588	0.99585	0.99582	0.99579	0.99576	0.99573	0.99570
30.	0.99567	0.99564	0.99561	0.99558	0.99555	0.99552	0.99549	0.99546	0.99543	0.99540

Density of C₂H₅OH given in g/cm³

According to the "American Institute of Physics Handbook".

T/°C	0.0	0.1	0.2	0.3	0.4	0.5	0.6	0.7	0.8	0.9
10.	0.79784	0.79775	0.79767	0.79758	0.79750	0.79741	0.79733	0.79725	0.79716	0.79708
11.	0.79699	0.79691	0.79682	0.79674	0.79665	0.79657	0.79648	0.79640	0.79631	0.79623
12.	0.79614	0.79606	0.79598	0.79589	0.79581	0.79572	0.79564	0.79555	0.79547	0.79538
13.	0.79530	0.79521	0.79513	0.79504	0.79496	0.79487	0.79479	0.79470	0.79462	0.79453
14.	0.79445	0.79436	0.79428	0.79419	0.79411	0.79402	0.79394	0.79385	0.79377	0.79368
15.	0.79360	0.79352	0.79343	0.79335	0.79326	0.79318	0.79309	0.79301	0.79292	0.79284
16.	0.79275	0.79267	0.79258	0.79250	0.79241	0.79232	0.79224	0.79215	0.79207	0.79198
17.	0.79190	0.79181	0.79173	0.79164	0.79156	0.79147	0.79139	0.79130	0.79122	0.79113
18.	0.79105	0.79096	0.79088	0.79079	0.79071	0.79062	0.79054	0.79045	0.79037	0.79028
19.	0.79020	0.79011	0.79002	0.78994	0.78985	0.78977	0.78968	0.78960	0.78951	0.78943
20.	0.78934	0.78926	0.78917	0.78909	0.78900	0.78892	0.78883	0.78874	0.78866	0.78857
21.	0.78849	0.78840	0.78832	0.78823	0.78815	0.78806	0.78797	0.78789	0.78780	0.78772
22.	0.78763	0.78755	0.78746	0.78738	0.78729	0.78720	0.78712	0.78703	0.78695	0.78686
23.	0.78678	0.78669	0.78660	0.78652	0.78643	0.78635	0.78626	0.78618	0.78609	0.78600
24.	0.78592	0.78583	0.78575	0.78566	0.78558	0.78549	0.78540	0.78532	0.78523	0.78515
25.	0.78506	0.78497	0.78489	0.78480	0.78472	0.78463	0.78454	0.78446	0.78437	0.78429
26.	0.78420	0.78411	0.78403	0.78394	0.78386	0.78377	0.78368	0.78360	0.78351	0.78343
27.	0.78334	0.78325	0.78317	0.78308	0.78299	0.78291	0.78282	0.78274	0.78265	0.78256
28.	0.78248	0.78239	0.78230	0.78222	0.78213	0.78205	0.78196	0.78187	0.78179	0.78170
29.	0.78161	0.78153	0.78144	0.78136	0.78127	0.78118	0.78110	0.78101	0.78092	0.78084
30.	0.78075	0.78066	0.78058	0.78049	0.78040	0.78032	0.78023	0.78014	0.78006	0.77997

7 Communication with Peripheral Devices

7.1 PC-Direct function

The PC-Direct function of the balance allows you to transfer weight values from the balance to a Windows application. The weight value displayed on the balance is transferred to the cursor position in, e.g., Excel or Word.

The weight value is transferred without the unit.

Requirements

- PC with one of the following Microsoft Windows® 32-bit/64-bit operating systems: Win 7 (SP1), Win 8 or Win 10
- Serial interface RS232C or USB
- Administrator rights for installing the SerialPortToKeyboard software (if data transfer is via RS232C)
- Windows application, e.g., Excel
- Connection between balance and PC via RS232C or USB cable

Installing SerialPortToKeyboard software

The operation of PC-Direct via serial port RS232C requires the installation of **SerialPortToKeyboard** on your host computer. The file **SerialPortToKeyboard** can be found on ► www.mt.com/labweighing-software-download. If you have any questions, please contact a METTLER TOLEDO representative.

Download SerialPortToKeyboard

- 1 Connect to the internet.
- 2 Go to the site www.mt.com/labweighing-software-download.
- 3 Click **Download Software and Instructions** in section **SerialPortToKeyboard software for Advanced and Standard level laboratory balances**.
 - ➔ A pop-up window with interactions appears.
- 4 Click, e.g., **Open**.
 - ➔ The extract screen appears.
- 5 Extract the file **SerialPortToKeyboard_V_x.xx_installer_and_instructions.zip** to your specified location.
- 6 Right-click on the downloaded installation program **SerialPortToKeyboard_V_x.xx.exe** and select **Run as Administrator**.
- 7 If a safety warning appears, confirm windows to perform the installation.
- 8 Click **Next** and follow the installer's instructions.

Checking operation

- 1 Start **SerialPortToKeyboard** (RS232C)
- 2 Start Excel (or another application) on the computer.
- 3 Activate a cell in Excel.

Settings on the PC

Settings for SerialPortToKeyboard

- 1 Select the serial port **COM** for the connection with the balance.
 - 2 Set the **Baud Rate** to **9600**.
 - 3 Activate **Connect**.
- Closing the window terminates the session.

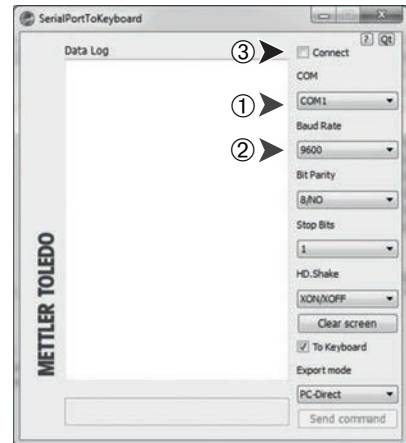

Settings at the balance

Balance interface settings, **see** "Interface menu".

- Topic **RS232** or **USB**: set **PC-DIR.** and select the most appropriate option for the desired weighing result.
- Topic **RS.TX.E.O.L./RS E.O.L.** or **USB E.O.L./USB E.O.L.**:
 - set **<TAB>** to write into the same row (e.g. in Excel).
 - set **<CR><LF>** to write into the same column (e.g. in Excel).
- Save changes.





















According to your selected **PC-DIR.** option, the displayed values will appear e.g. in the column one after the other one in the different rows.

7.2 Send weight value via RS232 to a PC using EasyDirect balance

The software EasyDirect Balance collects weighing results and additional data such as the date, time and the measurement unit. The data can be printed or saved in various data formats on a PC, e.g. as PDF or Excel file. The software can be ordered at METTLER TOLEDO and must be installed on a PC.

- EasyDirect Balance is installed on the PC according to the user requirements.
- The balance is connected to the PC via RS232 interface.

Configure balance

- 1 Press and hold .
 - ➔ The menu **BASIC** appears.
- 2 Press  repeatedly until the menu **INT.FACE** appears.
- 3 Press .
 - ➔ The menu topic **RS232** appears.
- 4 Press .
 - ➔ **PRINTER** appears.
- 5 Press .
- 6 Press  repeatedly and select a suitable mode, e.g. **PRT.STAB**.
- 7 Press  to confirm the selection.
 - ➔ The previously chosen menu topic appears.
- 8 Press .
 - ➔ The menu topic **HEADER** appears.
- 9 Press .
- 10 Press  repeatedly until **D/T/BAL** appears.
- 11 Press  to confirm the selection.
 - ➔ The previously chosen menu topic appears.
- 12 Press .
 - ➔ The menu topic **SINGLE** appears.
- 13 Press .
- 14 Press  repeatedly until **G / T / N** appears.
- 15 Press  to confirm the selection.
 - ➔ The previously chosen menu topic appears.
- 16 Press .
 - ➔ The menu topic **SIGN.L** appears.
- 17 Press .
- 18 Press  repeatedly until **ON** appears.
- 19 Press  to confirm the selection.
 - ➔ The previously chosen menu topic appears.
- 20 Press and hold .
 - ➔ **SAVE:YES** appears.
- 21 Press  to confirm the selection.
 - ➔ Changes are saved.



Note

If no changes have been made, the balance will switch to the weighing mode at step 20.

Transfer values

- 1 Start EasyDirect Balance on your PC.
- 2 Refer to the EasyDirect Balance Help menu to add the balance and to set up the connection.

- 3 Place the sample on the weighing pan.
 - ➔ The weighing result is transferred to EasyDirect Balance either automatically or when the print icon is pressed. This depends on the settings in the publishing menu of the balance.

8 Maintenance

To guarantee the functionality of the balance and the accuracy of the weighing results, a number of maintenance actions must be performed by the user.

8.1 Maintenance table

Maintenance action	Recommended interval	Remarks
Performing an internal adjustment	<ul style="list-style-type: none">• Daily• After cleaning• After leveling• After changing the location	see chapter "Adjustment with internal weight"
Performing routine tests (sensitivity test, repeatability test). METTLER TOLEDO recommends to perform at least a sensitivity test.	<ul style="list-style-type: none">• After cleaning	see below
Cleaning	Depending on the degree of pollution or your internal regulations (SOP), clean the instrument: <ul style="list-style-type: none">• After every use• After change of sample	see chapter "Cleaning the balance"

8.2 Performing routine tests

There are several routine tests. Depending on your internal regulations, specific routine test must be performed by the user.

METTLER TOLEDO recommends to perform an sensitivity test after cleaning and reassembling the balance.

8.3 Cleaning



WARNING

Death or serious injury due to electric shock

Contact with parts carrying a live current can lead to injury and death.

- 1 Disconnect the instrument from the power supply prior to cleaning and maintenance.
- 2 Prevent liquid from entering the instrument, terminal or AC/DC adapter.

8.3.1 Cleaning the glass draft shield



CAUTION

Injury due to breaking glass

Careless handling of the glass components can lead to breakage off glass and damage cuttings.

- Always proceed focused and with care.

Removing or inserting sliding glass doors

It is possible to remove the sliding glass doors for cleaning or for replacing.



Note

Front and rear glass panels cannot be removed.

- 1 Remove the handle first.
- 2 Remove the sliding glass doors.
- 3 Install the handle after insertion of the glass door.

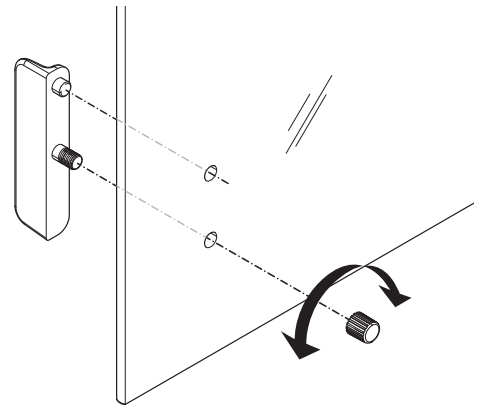

8.3.2 Cleaning the balance



NOTICE

Damage due to improper cleaning

Improper cleaning can damage the load cell or other essential parts.

- 1 Do not use any cleaning agents other than the ones specified in the "Reference Manual" or "Cleaning Guide".
- 2 Do not spray or pour liquids on the instrument. Always use a moistened lint-free cloth or a tissue.
- 3 Always wipe out from inside to outside of the instrument.



For further information on cleaning a balance, consult "8 Steps to a Clean Balance".

www.mt.com/lab-cleaning-guide

Cleaning around the balance

- Remove any dirt or dust around the balance and avoid further contaminations.

Cleaning the removable parts



- Clean the removed part with a damp cloth or a tissue and a mild cleaning agent.

Cleaning the balance

- 1 Disconnect the balance from the AC/DC adapter.

- 2 Use a lint-free cloth moistened with a mild cleaning agent to clean the surface of the balance.
- 3 Remove powder or dust at first with a disposable tissue.
- 4 Remove sticky substances with a damp lint-free cloth and a mild solvent.

8.3.3 Putting into operation after cleaning

- 1 Reassemble the balance.
 - 2 Check the functionality of the draft shield if applicable.
 - 3 Press  to switch on the balance.
 - 4 Warm up the balance. Wait 1h for the acclimatization, before starting the tests.
 - 5 Check the level status, level the balance if necessary.
 - 6 Perform an adjustment (internal or external).
 - 7 Perform a routine test due to the internal regulations of your company. METTLER TOLEDO recommends to perform an repeatability test after cleaning the balance.
 - 8 Press  to zero the balance.
- ➔ The balance has been put into operation and is ready to use.

See also

-  Leveling the balance ▶ Page 20

9 Troubleshooting

Possible errors with their cause and remedy are described in the following chapter. If there are errors that cannot be corrected through these instructions, contact METTLER TOLEDO.

9.1 Error messages

Error message	Possible cause	Diagnostic	Remedy
NO STABILITY	Vibrations at the workplace.	Place beaker with tap water on the weighing table. Vibrations cause ripples on the water surface.	<ul style="list-style-type: none"> Protect weighing location against vibrations (vibration absorber, etc.). Set weighing parameters coarser (change ENVIRON. from STABLE to STANDARD or even UNSTABLE). Find a different weighing location.
	Draft due to untight draft shield and /or open window.	Make sure draft shield or window is closed.	<ul style="list-style-type: none"> Close draft shield or window. Set weighing parameters coarser (change ENVIRON. from STABLE to STANDARD or even UNSTABLE).
	The location is not suitable for weighing.	–	Check and observe the requirements for the location, refer to "Selecting the location".
	Something is touching the weighing pan.	Check for touching parts or dirt.	Remove touching parts or clean the balance.
WRONG ADJUSTMENT WEIGHT	Wrong adjustment weight.	Check weight.	Place correct weight on the weighing pan.
REFERENCE TOO SMALL	Reference for piece counting too small.	–	Increase reference weight.
EEPROM ERROR - PLEASE CONTACT CUSTOMER SERVICE	Data in EEPROM damaged.	–	Please contact your METTLER TOLEDO customer service.
WRONG CELL DATA - PLEASE CONTACT CUSTOMER SERVICE	Defect load cell data.	–	Please contact your METTLER TOLEDO customer service.
NO STANDARD ADJUSTMENT - PLEASE CONTACT CUSTOMER SERVICE	–	–	Please contact your METTLER TOLEDO customer service.
PROGRAM MEMORY DEFECT - PLEASE CONTACT CUSTOMER SERVICE	–	–	Please contact your METTLER TOLEDO customer service.

Error message	Possible cause	Diagnostic	Remedy
TEMP SENSOR DEFECT - PLEASE CONTACT CUSTOMER SERVICE	AC/DC adapter connected to power before connecting to the balance. Temperature sensor of load cell defect.	–	Remove the AC/DC adapter from the power and connect first to the balance before connecting to the power if persist please contact your METTLER TOLEDO customer service.
WRONG LOAD CELL BRAND - PLEASE CONTACT CUSTOMER SERVICE	Wrong load cell installed.	–	Please contact your METTLER TOLEDO customer service.
WRONG TYPE DATA SET - PLEASE CONTACT CUSTOMER SERVICE	Wrong type data set.	–	Please contact your METTLER TOLEDO customer service.
BATTERY BACKUP LOST - CHECK DATE TIME SETTINGS	Backup battery/capacitor is empty. This battery/capacitor ensures that the date and time are not lost when the balance is disconnected from power.	The battery/capacitor provides enough power for approximately 2 days when having the balance not connected to the power supply.	Connect the balance to the power supply for charging the battery (e.g., during the night) or contact METTLER TOLEDO customer service.
ABOVE INITIAL ZERO RANGE	Wrong weighing pan. Pan is not empty.	Check weighing pan.	Mount correct weighing pan or unload weighing pan.
BELOW INITIAL ZERO RANGE	Wrong weighing pan. Pan is missing.	Check weighing pan.	Mount correct weighing pan.
MEM FULL	Memory full.	–	Clear the memory by finishing all applications where a measurement is ongoing.
FACTOR OUT OF RANGE	Factor is outside the allow range.	–	Select a new factor.
STEP OUT OF RANGE	Step is outside the allow range.	–	Select a new step.
OUT OF RANGE	Sample weight is outside the allow range.	–	Unload the pan and load a new sample weight.

9.2 Error symptoms

Error symptom	Possible cause	Diagnostic	Remedy
Display is dark	Instrument is switched off.	–	Switch on the instrument.
	Power plug not connected.	Check	Connect power cable to power supply.
	Power supply not connected to balance.	Check	Connect power supply.
	Power supply is faulty.	Check/test	Replace power supply.
	Wrong power supply.	Check that input data on type plate match the power supply values.	Use proper power supply.
	Connector socket on balance is corroded or faulty.	Check	Please contact your METTLER TOLEDO customer service.

Error symptom	Possible cause	Diagnostic	Remedy
	Display is faulty.	Replace display.	Please contact your METTLER TOLEDO customer service.
Operation Keys do not work	Keypad is defective.	–	Please contact your METTLER TOLEDO customer service.
The value drifts into plus or minus	Room, environment not suitable.	–	<p>Environmental recommendations</p> <ul style="list-style-type: none"> • Windowless, non air-conditioned room, e.g., basement. • Only one person in the weighing room. • Sliding doors. Standard doors cause pressure changes. • No draft in weighing room (check with suspended threads). • No air conditioning (temperature oscillates, draft). • Acclimatize balance, take dummy measurements. • Instrument uninterruptedly connected to the power supply (24h per day).
	Direct sunlight or other heat source.	Is any sun shade (blinds, curtains, etc.) available?	Select location according to "Selecting the location" (customer responsibility).
	Weighing sample absorbs moisture or evaporates moisture.	<ul style="list-style-type: none"> • Is the weighing result with a test weight stable? • Sensitive weighing samples, e.g., paper, cardboard, wood, plastic, rubber, liquids. 	<ul style="list-style-type: none"> • Use aids. • Cover weighing sample.
	Weighing sample is electrostatically charged.	<ul style="list-style-type: none"> • Is the weighing result with a test weight stable? • Sensitive weighing samples, e.g., plastic, powder, insulating materials. 	<ul style="list-style-type: none"> • Increase air humidity in weighing chamber (45% - 50%). • Use ionizer.
	Weighing sample is hotter or colder than the air in the weighing chamber.	Weighing operation with test weight does not show this effect.	Bring weighing sample to room temperature before weighing.

Error symptom	Possible cause	Diagnostic	Remedy
	Instrument has not yet reached thermal equilibrium.	<ul style="list-style-type: none"> Was there a power outage? Was power supply disconnected? 	<ul style="list-style-type: none"> Acclimatize instrument for at least 1 hour. Depending on climatic conditions, extend this period accordingly. Instrument switched on for at least 1 hour, refer to "General data"
Display shows overload or underload	The weight on the weighing pan exceeds the weighing capacity of the instrument.	Check weight.	Reduce the weight on the weighing pan.
	Wrong weighing pan.	Slightly lift or press weighing pan. The weight display appears.	Use proper weighing pan.
	No weighing pan.	–	Install weighing pan.
	Incorrect zero point at switch-on.	–	<ul style="list-style-type: none"> Switch off balance. Disconnect and reconnect power cable.
Display flashes 0.0000	Loose cables.	Check all cable connections.	Connect all cables. Please contact your METTLER TOLEDO customer service if the problem persists.
Taring not possible	Vibrations at the workplace.	Display unstable.	Press Tare again.
		Place beaker with tap water on the weighing table. Vibrations cause ripples on the water surface.	<ul style="list-style-type: none"> Protect weighing location against vibrations (vibration absorber, etc.). Set weighing parameters coarser (change ENVIRON. from STABLE to STANDARD or even UNSTABLE). Find a different weighing location (by agreement with customer).

9.3 Status icons

Icon	Status description	Diagnostic	Remedy
	Service due.	See menu topic SERV.ICON in chapter "Description of menu topic" -> "Advanced menu".	Please contact your METTLER TOLEDO-Support representative.

9.4 Putting into operation after fixing an error

After fixing an error, perform the following steps to put the balance into operation:

- Ensure that the balance is completely reassembled and cleaned.
- Reconnect the balance to the AC/DC adapter.

10 Technical Data

10.1 General data

Standard power supply

AC/DC adapter:	Input: 100 – 240 V AC \pm 10%, 50 – 60 Hz, 0.5 A, 24 – 34 VA Output: 12 V DC, 1.0 A, LPS (Limited Power Source)
Polarity:	
Balance power consumption:	12 V DC, 0.3 A If the balance is used above 2000 m mean sea level, the optional power supply must be used.

Optional power supply

AC/DC adapter:	Input: 100 – 240 V AC \pm 10%, 50 – 60 Hz, 0.8 A, 60 – 80 VA Output: 12 V DC, 2.5 A, LPS (Limited Power Source)
Cable for AC/DC adapter:	3-core, with country-specific plug
Polarity:	
Balance power consumption:	12 V DC, 0.3 A

Protection and standards

Overvoltage category:	II
Degree of pollution:	2
Protection:	Protected against dust and water
Standards for safety and EMC:	See Declaration of Conformity
Range of application:	Use only indoors in dry locations

Environmental conditions

Height above mean sea level:	Up to 2000 m (standard power supply) Up to 4000 m (optional power supply)
Ambient temperature:	+5 °C – +40 °C
Storage condition:	-25 °C – +70 °C
Relative air humidity:	Max. 80% up to 31 °C, linearly decreasing to 50% at 40 °C, non-condensing
Warm-up time:	At least 30 minutes (0.01 mg and 0.1 mg models 60 minutes) after connecting the balance to the power supply.

Materials

Housing:	Top Housing: ABS Bottom housing: Die-cast aluminum, lacquered
Weighing pan:	Ø 80 mm and 90 mm: Stainless steel X2CrNiMo 17-12-2 (1.4404) All others: Stainless steel X5CrNi 18-10 (1.4301)
Draft shield element:	0.01 mg and 0.1 mg models: Stainless steel X5CrNi 18-10 (1.4301) 10 mg models: ABS
Draft shield:	ABS, glass
Protective cover:	PET
Backup battery:	Capacitor (saves date and time for approximately two days)

10.2 Model-specific data

10.2.1 Gold balances with readability of 0.01 mg

	JE155DUG
Limit values	
Capacity	152 g
Nominal load	140 g
Readability	0.1 mg
Capacity of fine range	42 g
Readability in fine range	0.01 mg
Repeatability (at 5% load)	0.03 mg
Linearity deviation	0.2 mg
Eccentricity deviation (at test load)	0.2 mg (50 g)
Sensitivity offset (at nominal load) ¹⁾	0.8 mg
Sensitivity temperature drift ²⁾	0.0002 %/°C
Typical values	
Repeatability (at 5% load)	0.02 mg
Linearity deviation	0.1 mg
Eccentricity deviation (at test load)	0.15 mg (50 g)
Minimum weight (tolerance=1%) ³⁾	4 mg
Settling time	5 s
Adjustment	Internal
Balance dimensions (W × D × H)	210×344×279 mm
Weighing pan diameter	80 mm
Usable height of draft shield	173 mm
Balance weight	4.6 kg
Weights for routine testing	
Weights (OIML class)	5 g (F2) / 100 g (F2)
Weights (ASTM class)	5 g (ASTM 1) / 100 g (ASTM 1)

¹⁾ after sensitivity adjustment

²⁾ In the temperature range +10 °C – +30 °C

³⁾ determined at 5% load, k = 2

10.2.2 Carat balances with readability of 0.001 ct / 0.1 mg

	JE503C	JE503CE
Limit values		
Capacity	505 ct / 101 g	505 ct / 101 g
Nominal load	100 g	100 g
Readability	0.001 ct / 0.1 mg	0.001 ct / 0.1 mg
Repeatability	0.1 mg	0.1 mg
Linearity deviation	0.2 mg	0.2 mg
Eccentricity deviation (at test load)	0.4 mg (50 g)	0.4 mg (50 g)
Sensitivity offset (at nominal load) ¹⁾	1 mg	1 mg
Sensitivity temperature drift ²⁾	0.0002 %/°C	0.0002 %/°C
Typical values		
Repeatability	0.08 mg	0.08 mg
Linearity deviation	0.06 mg	0.06 mg
Eccentricity deviation (at test load)	0.15 mg (50 g)	0.15 mg (50 g)
Minimum weight (tolerance=1 %) ³⁾	16 mg	16 mg
Settling time	2 s	2 s
Adjustment	Internal	External
Balance dimensions (W × D × H)	210×344×279 mm	210×344×279 mm
Weighing pan diameter	90 mm	90 mm
Usable height of draft shield	173 mm	173 mm
Balance weight	4.6 kg	4.4 kg
Weights for routine testing		
Weights (OIML class)	5 g (F2)/ 100 g (F2)	5 g (F2)/ 100 g (F2)
Weights (ASTM class)	5 g (ASTM 1)/ 100 g (ASTM 1)	5 g (ASTM 1)/ 100 g (ASTM 1)

¹⁾ after sensitivity adjustment

²⁾ In the temperature range +10 °C – +30 °C

³⁾ determined at 5% load, k = 2

	JE703C	JE703CE
Limit values		
Capacity	700 ct / 140 g	700 ct / 140 g
Nominal load	140 g	100 g
Readability	0.001 ct / 0.1 mg	0.001 ct / 0.1 mg
Repeatability	0.1 mg	0.1 mg
Linearity deviation	0.2 mg	0.2 mg
Eccentricity deviation (at test load)	0.4 mg (50 g)	0.4 mg (50 g)
Sensitivity offset (at nominal load) ¹⁾	1 mg	1 mg
Sensitivity temperature drift ²⁾	0.0003 %/°C	0.0003 %/°C
Typical values		
Repeatability	0.08 mg	0.08 mg
Linearity deviation	0.06 mg	0.06 mg
Eccentricity deviation (at test load)	0.15 mg (50 g)	0.15 mg (50 g)
Minimum weight (tolerance=1%) ³⁾	16 mg	16 mg
Settling time	2 s	2 s
Adjustment	Internal	External
Balance dimensions (W × D × H)	210×344×279 mm	210×344×279 mm
Weighing pan diameter	90 mm	90 mm
Usable height of draft shield	173 mm	173 mm
Balance weight	4.6 kg	4.7 kg
Weights for routine testing		
Weights (OIML class)	5 g (F2)/ 100 g (F2)	5 g (F2)/ 100 g (F2)
Weights (ASTM class)	5 g (ASTM 1)/ 100 g (ASTM 1)	5 g (ASTM 1)/ 100 g (ASTM 1)

¹⁾ after sensitivity adjustment

²⁾ In the temperature range +10 °C – +30 °C

³⁾ determined at 5% load, k = 2

	JE1103C	JE1103CE
Limit values		
Capacity	1100 ct / 220 g	1100 ct / 220 g
Nominal load	200 g	200 g
Readability	0.001 ct / 0.1 mg	0.001 ct / 0.1 mg
Repeatability	0.1 mg	0.1 mg
Linearity deviation	0.2 mg	0.2 mg
Eccentricity deviation (at test load)	0.4 mg (100 g)	0.4 mg (100 g)
Sensitivity offset (at nominal load) ¹⁾	1 mg	1 mg
Sensitivity temperature drift ²⁾	0.0003 %/°C	0.0003 %/°C
Typical values		
Repeatability	0.08 mg	0.08 mg
Linearity deviation	0.06 mg	0.06 mg
Eccentricity deviation (at test load)	0.15 mg (100 g)	0.15 mg (100 g)
Minimum weight (tolerance=1 %) ³⁾	16 mg	16 mg
Settling time	2 s	2 s
Adjustment	Internal	External
Balance dimensions (W × D × H)	210×344×279 mm	210×344×279 mm
Weighing pan diameter	90 mm	90 mm
Usable height of draft shield	173 mm	173 mm
Balance weight	4.6 kg	4.4 kg
Weights for routine testing		
Weights (OIML class)	10 g (F2)/ 200 g (F2)	10 g (F2)/ 200 g (F2)
Weights (ASTM class)	10 g (ASTM 1)/ 200 g (ASTM 1)	10 g (ASTM 1)/ 200 g (ASTM 1)

¹⁾ after sensitivity adjustment

²⁾ In the temperature range +10 °C – +30 °C

³⁾ determined at 5% load, k = 2

10.2.3 Gold balances with readability of 0.1 mg and 1 mg

	JE203G	JE203GE
Limit values		
Capacity	220 g	220 g
Nominal load	200 g	200 g
Readability	1 mg	1 mg
Repeatability	1 mg	1 mg
Linearity deviation	2 mg	2 mg
Eccentricity deviation (at test load)	4 mg (100 g)	4 mg (200 g)
Sensitivity offset (at nominal load) ¹⁾	8 mg	8 mg
Sensitivity temperature drift ²⁾	0.0003 %/°C	0.0003 %/°C
Typical values		
Repeatability	0.7 mg	0.7 mg
Linearity deviation	0.6 mg	0.6 mg
Eccentricity deviation (at test load)	1.5 mg (100 g)	1.5 mg (200 g)
Sensitivity offset (at nominal load) ¹⁾	5 mg	5 mg
Minimum weight (tolerance=1%) ³⁾	140 mg	140 mg
Settling time	2 s	2 s
Adjustment	Internal	External
Balance dimensions (W × D × H)	210×319×289 mm	210×319×289 mm
Weighing pan diameter	120 mm	120 mm
Usable height of draft shield	172.6 mm	172.6 mm
Balance weight	4.6 kg	4.4 kg
Weights for routine testing		
Weights (OIML class)	10 g (F2)/ 200 g (F2)	10 g (F2)/ 200 g (F2)
Weights (ASTM class)	10 g (ASTM 1)/ 200 g (ASTM 1)	10 g (ASTM 1)/ 200 g (ASTM 1)

¹⁾ after sensitivity adjustment

²⁾ In the temperature range +10 °C – +30 °C

³⁾ determined at 5% load, k = 2

	JE204G/81
Limit values	
Capacity	220 g
Nominal load	200 g
Readability	0.1 mg
Repeatability	0.1 mg
Linearity deviation	0.2 mg
Eccentricity deviation (at test load)	0.4 mg (100 g)
Sensitivity offset (at nominal load) ¹⁾	1 mg
Sensitivity temperature drift ²⁾	0.0003 %/°C
Typical values	
Repeatability	0.08 mg
Linearity deviation	0.06 mg
Eccentricity deviation (at test load)	0.15 mg (100 g)
Minimum weight (tolerance=1 %) ³⁾	16 mg
Settling time	2 s
Adjustment	Internal
Balance dimensions (W × D × H)	210×344×279 mm
Weighing pan diameter	90 mm
Usable height of draft shield	173 mm
Balance weight	4.6 kg
Weights for routine testing	
Weights (OIML class)	10 g (F2)/ 200 g (F2)
Weights (ASTM class)	10 g (ASTM 1)/ 200 g (ASTM 1)

¹⁾ after sensitivity adjustment

²⁾ In the temperature range +10 °C – +30 °C

³⁾ determined at 5% load, k = 2

	JE303G	JE303GE
Limit values		
Capacity	320 g	320 g
Nominal load	300 g	300 g
Readability	1 mg	1 mg
Repeatability	1 mg	1 mg
Linearity deviation	2 mg	2 mg
Eccentricity deviation (at test load)	4 mg (100 g)	4 mg (200 g)
Sensitivity offset (at nominal load) ¹⁾	8 mg	8 mg
Sensitivity temperature drift ²⁾	0.0003 %/°C	0.0003 %/°C
Typical values		
Repeatability	0.7 mg	0.7 mg
Linearity deviation	0.6 mg	0.6 mg
Eccentricity deviation (at test load)	1.5 mg (100 g)	1.5 mg (200 g)
Sensitivity offset (at nominal load) ¹⁾	5 mg	5 mg
Minimum weight (tolerance=1%) ³⁾	140 mg	140 mg
Settling time	2 s	2 s
Adjustment	Internal	External
Balance dimensions (W × D × H)	210×319×289 mm	210×319×289 mm
Weighing pan diameter	120 mm	120 mm
Usable height of draft shield	172.6 mm	172.6 mm
Balance weight	4.6 kg	4.6 kg
Weights for routine testing		
Weights (OIML class)	10 g (F2)/ 200 g (F2)	10 g (F2)/ 200 g (F2)
Weights (ASTM class)	10 g (ASTM 1)/ 200 g (ASTM 1)	10 g (ASTM 1)/ 200 g (ASTM 1)

¹⁾ after sensitivity adjustment

²⁾ In the temperature range +10 °C – +30 °C

³⁾ determined at 5% load, k = 2

	JE503G	JE503GE
Limit values		
Capacity	520 g	520 g
Nominal load	500 g	500 g
Readability	1 mg	1 mg
Repeatability	1 mg	1 mg
Linearity deviation	2 mg	2 mg
Eccentricity deviation (at test load)	4 mg (200 g)	4 mg (200 g)
Sensitivity offset (at nominal load) ¹⁾	8 mg	8 mg
Sensitivity temperature drift ²⁾	0.0003 %/°C	0.0003 %/°C
Typical values		
Repeatability	0.7 mg	0.7 mg
Linearity deviation	0.6 mg	0.6 mg
Eccentricity deviation (at test load)	1.5 mg (200 g)	1.5 mg (200 g)
Sensitivity offset (at nominal load) ¹⁾	5 mg	5 mg
Minimum weight (tolerance=1 %) ³⁾	140 mg	140 mg
Settling time	1.5 s	1.5 s
Adjustment	Internal	External
Balance dimensions (W × D × H)	210×319×289 mm	210×319×289 mm
Weighing pan diameter	120 mm	120 mm
Usable height of draft shield	172.6 mm	172.6 mm
Balance weight	4.6 kg	4.4 kg
Weights for routine testing		
Weights (OIML class)	20 g (F2)/ 500 g (F2)	20 g (F2)/ 500 g (F2)
Weights (ASTM class)	20 g (ASTM 1)/ 500 g (ASTM 1)	20 g (ASTM 1)/ 500 g (ASTM 1)

¹⁾ after sensitivity adjustment

²⁾ In the temperature range +10 °C – +30 °C

³⁾ determined at 5% load, k = 2

10.2.4 Gold balances with readability of 10 mg

	JE1002G	JE1002GE
Limit values		
Capacity	1200 g	1200 g
Nominal load	1000 g	1000 g
Readability	10 mg	10 mg
Repeatability	10 mg	10 mg
Linearity deviation	20 mg	20 mg
Eccentricity deviation (at test load)	40 mg (500 g)	40 mg (500 g)
Sensitivity offset (at nominal load) ¹⁾	80 mg	80 mg
Sensitivity temperature drift ²⁾	0.0003 %/°C	0.0003 %/°C
Typical values		
Repeatability	7 mg	7 mg
Linearity deviation	6 mg	6 mg
Eccentricity deviation (at test load)	20 mg (500 g)	20 mg (500 g)
Sensitivity offset (at nominal load) ¹⁾	70 mg	70 mg
Minimum weight (tolerance=1%) ³⁾	1.4 g	1.4 g
Settling time	1 s	1 s
Adjustment	Internal	External
Balance dimensions (W × D × H)	200×319×100 mm	200×319×100 mm
Weighing pan dimensions (W × D)	180×180 mm	180×180 mm
Balance weight	3.7 kg	3.1 kg
Weights for routine testing		
Weights (OIML class)	50 g (F2)/ 1000 g (F2)	50 g (F2)/ 1000 g (F2)
Weights (ASTM class)	50 g (ASTM 1)/ 1000 g (ASTM 1)	50 g (ASTM 1)/ 1000 g (ASTM 1)

¹⁾ after sensitivity adjustment

²⁾ In the temperature range +10 °C – +30 °C

³⁾ determined at 5% load, k = 2

	JE2002G	JE2002GE
Limit values		
Capacity	2200 g	2200 g
Nominal load	2000 g	2000 g
Readability	10 mg	10 mg
Repeatability	10 mg	10 mg
Linearity deviation	20 mg	20 mg
Eccentricity deviation (at test load)	40 mg (1000 g)	40 mg (1000 g)
Sensitivity offset (at nominal load) ¹⁾	80 mg	80 mg
Sensitivity temperature drift ²⁾	0.0003 %/°C	0.0003 %/°C
Typical values		
Repeatability	7 mg	7 mg
Linearity deviation	6 mg	6 mg
Eccentricity deviation (at test load)	20 mg (1000 g)	20 mg (1000 g)
Sensitivity offset (at nominal load) ¹⁾	70 mg	70 mg
Minimum weight (tolerance=1 %) ³⁾	1.4 g	1.4 g
Settling time	1 s	1 s
Adjustment	Internal	External
Balance dimensions (W × D × H)	200×319×100 mm	200×319×100 mm
Weighing pan dimensions (W × D)	180×180 mm	180×180 mm
Balance weight	3.7 kg	3.1 kg
Weights for routine testing		
Weights (OIML class)	100 g (F2)/ 2000 g (F2)	100 g (F2)/ 2000 g (F2)
Weights (ASTM class)	100 g (ASTM 1)/ 2000 g (ASTM 1)	100 g (ASTM 1)/ 2000 g (ASTM 1)

¹⁾ after sensitivity adjustment

²⁾ In the temperature range +10 °C – +30 °C

³⁾ determined at 5% load, k = 2

	JE3002G	JE3002GE
Limit values		
Capacity	3200 g	3200 g
Nominal load	3000 g	3000 g
Readability	10 mg	10 mg
Repeatability	10 mg	10 mg
Linearity deviation	20 mg	20 mg
Eccentricity deviation (at test load)	40 mg (1000 g)	40 mg (1000 g)
Sensitivity offset (at nominal load) ¹⁾	80 mg	80 mg
Sensitivity temperature drift ²⁾	0.0003 %/°C	0.0003 %/°C
Typical values		
Repeatability	7 mg	7 mg
Linearity deviation	6 mg	6 mg
Eccentricity deviation (at test load)	20 mg (1000 g)	20 mg (1000 g)
Sensitivity offset (at nominal load) ¹⁾	70 mg	70 mg
Minimum weight (tolerance=1%) ³⁾	1.4 g	1.4 g
Settling time	1 s	1 s
Adjustment	Internal	External
Balance dimensions (W × D × H)	200×319×100 mm	200×319×100 mm
Weighing pan dimensions (W × D)	180×180 mm	180×180 mm
Balance weight	3.7 kg	3.1 kg
Weights for routine testing		
Weights (OIML class)	100 g (F2)/ 2000 g (F2)	100 g (F2)/ 2000 g (F2)
Weights (ASTM class)	100 g (ASTM 1)/ 2000 g (ASTM 1)	100 g (ASTM 1)/ 2000 g (ASTM 1)

¹⁾ after sensitivity adjustment

²⁾ In the temperature range +10 °C – +30 °C

³⁾ determined at 5% load, k = 2

	JE4002G	JE4002GE
Limit values		
Capacity	4200 g	4200 g
Nominal load	4000 g	4000 g
Readability	10 mg	10 mg
Repeatability	10 mg	10 mg
Linearity deviation	20 mg	20 mg
Eccentricity deviation (at test load)	40 mg (2000 g)	40 mg (2000 g)
Sensitivity offset (at nominal load) ¹⁾	80 mg	80 mg
Sensitivity temperature drift ²⁾	0.0003 %/°C	0.0003 %/°C
Typical values		
Repeatability	7 mg	7 mg
Linearity deviation	6 mg	6 mg
Eccentricity deviation (at test load)	20 mg (2000 g)	20 mg (2000 g)
Sensitivity offset (at nominal load) ¹⁾	70 mg	70 mg
Minimum weight (tolerance=1 %) ³⁾	1.4 g	1.4 g
Settling time	1 s	1 s
Adjustment	Internal	External
Balance dimensions (W × D × H)	200×319×100 mm	200×319×100 mm
Weighing pan dimensions (W × D)	180×180 mm	180×180 mm
Balance weight	3.7 kg	3.1 kg
Weights for routine testing		
Weights (OIML class)	200 g (F2)/ 2000 g (F2)	200 g (F2)/ 2000 g (F2)
Weights (ASTM class)	200 g (ASTM 4)/ 2000 g (ASTM 4)	200 g (ASTM 4)/ 2000 g (ASTM 4)

¹⁾ after sensitivity adjustment

²⁾ In the temperature range +10 °C – +30 °C

³⁾ determined at 5% load, k = 2

	JE5002G	JE5002GE
Limit values		
Capacity	5200 g	5200 g
Nominal load	5000 g	5000 g
Readability	10 mg	10 mg
Repeatability	10 mg	10 mg
Linearity deviation	20 mg	20 mg
Eccentricity deviation (at test load)	40 mg (2000 g)	40 mg (2000 g)
Sensitivity offset (at nominal load) ¹⁾	80 mg	80 mg
Sensitivity temperature drift ²⁾	0.0003 %/°C	0.0003 %/°C
Typical values		
Repeatability	7 mg	7 mg
Linearity deviation	6 mg	6 mg
Eccentricity deviation (at test load)	15 mg (2000 g)	15 mg (2000 g)
Sensitivity offset (at nominal load) ¹⁾	60 mg	60 mg
Minimum weight (tolerance=1%) ³⁾	1.4 g	1.4 g
Settling time	1.5 s	1.5 s
Adjustment	Internal	External
Balance dimensions (W × D × H)	200×319×100 mm	200×319×100 mm
Weighing pan dimensions (W × D)	180×180 mm	180×180 mm
Balance weight	3.7 kg	3.1 kg
Weights for routine testing		
Weights (OIML class)	200 g (F2)/ 5000 g (F2)	200 g (F2)/ 5000 g (F2)
Weights (ASTM class)	200 g (ASTM 4)/ 5000 g (ASTM 4)	200 g (ASTM 4)/ 5000 g (ASTM 4)

¹⁾ after sensitivity adjustment

²⁾ In the temperature range +10 °C – +30 °C

³⁾ determined at 5% load, k = 2

10.3 Dimensions

10.3.1 Gold balances with readability of 0.01 mg

Models:

JE155DUG

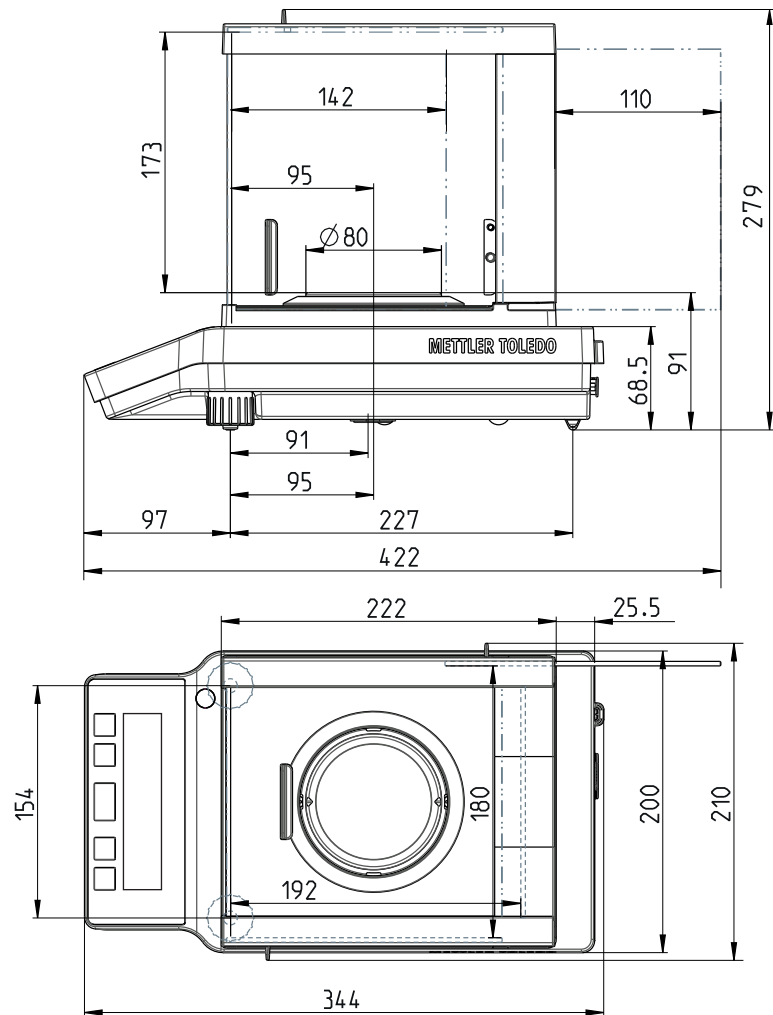

10.3.2 Carat balances with readability of 0.001 ct / 0.1 mg

Models:

- JE503C
- JE503CE
- JE703C
- JE703CE
- JE1103C
- JE1103CE

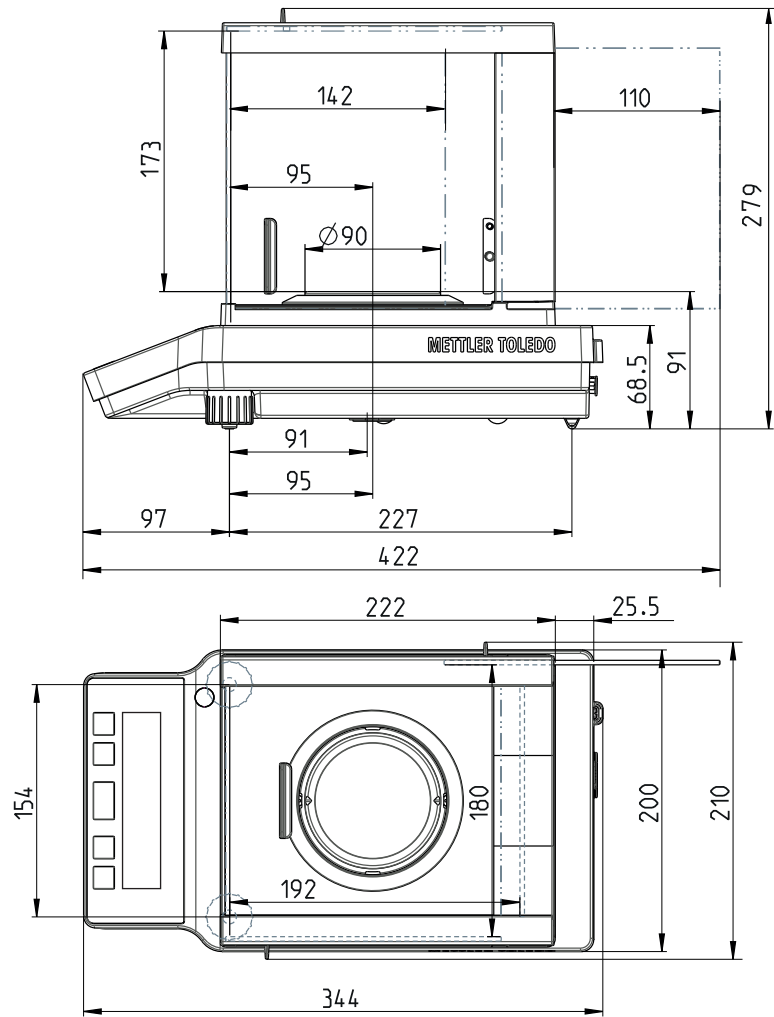

10.3.3 Gold balances with readability of 0.1 mg and 1 mg

Models:

- JE203G
- JE203GE
- JE204G/81
- JE303G
- JE303GE
- JE503G
- JE503GE

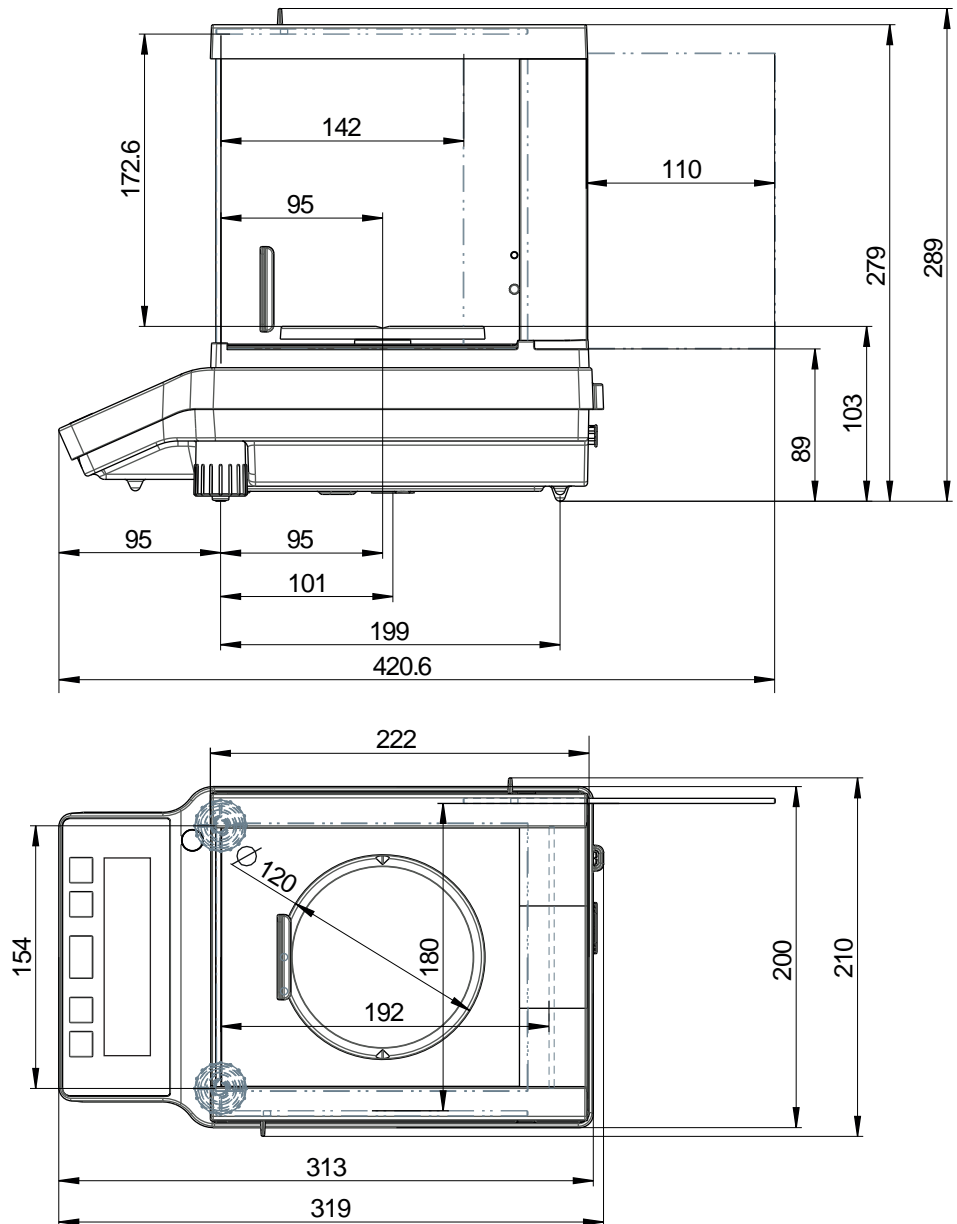

10.3.4 Gold balances with readability of 10 mg

Models:

- JE1002G
- JE1002GE
- JE2002G
- JE2002GE
- JE3002G
- JE3002GE
- JE4002G
- JE4002GE
- JE5002G
- JE5002GE

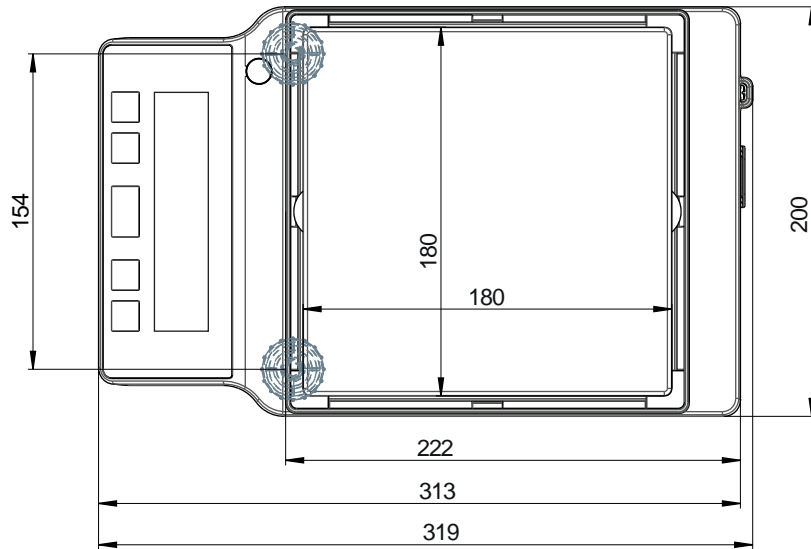
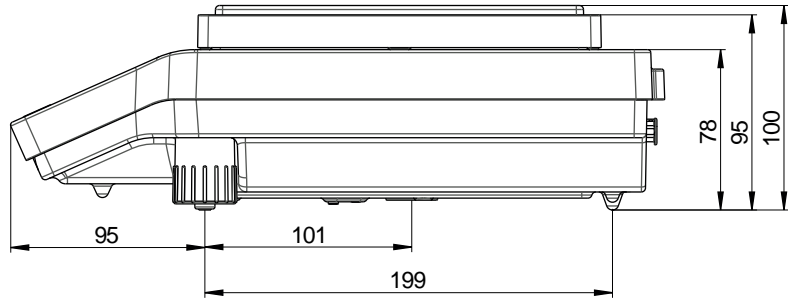

10.4 Interface specification

10.4.1 RS232C interface

Each balance is equipped with a RS232C Interface as standard for the attachment of a peripheral device, e.g., a printer or a computer.

Schematic	Item	Specification
	Interface type	Voltage interface according to EIA RS232C/ DIN66020 CCITT V24/V.28)
	Max. cable length	15 m
	Signal level	Outputs: +5 V ... +15 V (RL = 3–7 kΩ) –5 V ... –15 V (RL = 3–7 kΩ) Inputs: +3 V ... +25 V –3 V ... –25 V
	Connector	Sub-D, 9-pole, female
	Operating mode	Full duplex
	Transmission mode	Bit-serial, asynchronous
	Transmission code	ASCII
	Baud rates	600, 1200, 2400, 4800, 9600, 19200, 38400 (software selectable)
	Bits/parity	7-bit/none, 7-bit/even, 7-bit/odd, 8-bit/none (software selectable)
	Stop bits	1 stop bit
	Handshake	None, XON/XOFF, RTS/CTS (software selectable)
	End-of-line	<CR><LF>, <CR>, <LF> (software selectable)
	Power supply for 2nd display	+ 12 V, max 40 mA (software selectable, 2nd display mode only)

10.4.2 MT-SICS interface commands and functions

Many of the instruments and balances used have to be able to integrate into a complex computer or data acquisition system.

To easily integrate a balance into a system and utilize its capacity to the full extent, most balance functions are also available as corresponding commands via the data interface.

All new METTLER TOLEDO balances launched on the market support "METTLER TOLEDO Standard Interface Command Set" (MT-SICS). The commands available depend on the functionality of the balance.

For further information, please contact your METTLER TOLEDO representative.



Refer to the MT-SICS Reference Manual.





www.mt.com/library

11 Accessories and Spare Parts

11.1 Accessories

Accessories

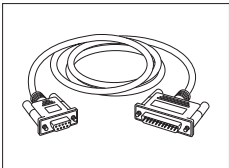
Accessories are additional components that could help you in your workflow.

	Description	Order no.
Printers		
	RS-P28/11 printer with RS232C connection to balance (with date, time and applications)	11124309
	Paper roll (length: 20 m), set of 5 pcs	00072456
	Paper roll (length: 13 m), self-adhesive, set of 3 pcs	11600388
	Ribbon cartridge, black, set of 2 pcs	00065975
	RS-P25 printer with RS232C connection to instrument	30702967
	Paper roll (length: 20 m), set of 5 pcs	00072456
	Paper roll (length: 13 m), self-adhesive, set of 3 pcs	11600388
	Ribbon cartridge, black, set of 2 pcs	00065975
Cables for RS232C interfaces		
	RS9 connection cable (to connect the instrument to a PC) Length: 1 m	11101051
	RS9 – RS25 (m/f): connection cable for PC, length = 2 m	11101052
	USB-RS232 cable (to connect the instrument via RS232C to a USB port)	64088427
Density determination		
	Density Kit Advanced & Standard for balance models with a readability of 0.1 mg / 1 mg	30535760

Carat pans

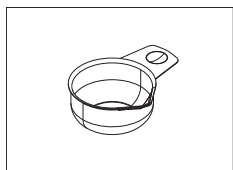

Carat pan XS, \varnothing 50 mm / height 20 mm (set of 10 units)

12102565

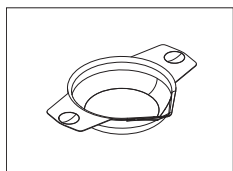

Carat pan S, \varnothing 80 mm / height 20 mm (set of 10 units)

12102645

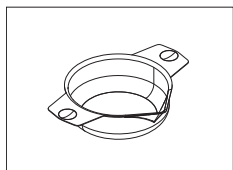

Carat pan M, \varnothing 90 mm / height 30 mm (set of 10 units)

12102646

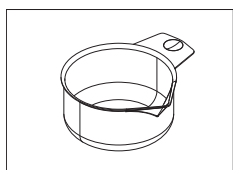

Carat pan L, \varnothing 90 mm / height 45 mm (set of 10 units)

12102647

Weighing pans

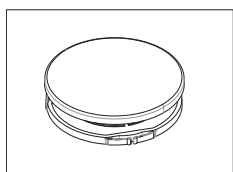

Set of weighing pan \varnothing 160 mm with pan support for balances with readability of 10 mg and 100 mg using draft shield

30042896

Draft shields

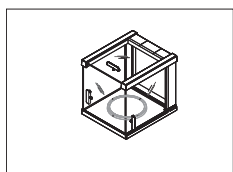

Draft shield low with sliding doors, usable height 170 mm.

30042884

- for balances 0.01 mg or 1 mg
- for balances 10 mg or 100 mg, weighing pan \varnothing 160 mm is needed (#30042896)

Auxiliary displays



RS232 auxiliary display AD-RS-J7

12122380

Protective covers

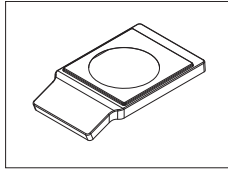

Protective cover for models with readability of 0.01 mg / 0.1 mg

30241549

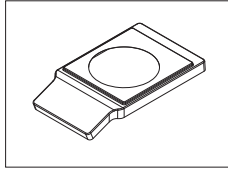

Protective cover for models with readability of 1 mg / 100 mg

30241560

Dust covers

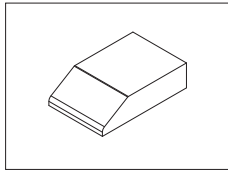

Dust cover for models without draft shield

30029051

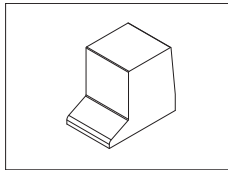

Dust cover for models with draft shield low (170 mm)

30029050

Anti-theft devices



Anti-theft cable with lock

11600361

Software



EasyDirect Balance is an application software to collect, analyze, store and export balance measurement and device data on PC.

License EasyDirect Balance for 10 Instruments

30540473

License EasyDirect Balance for 3 Instruments

30539323

Miscellaneous

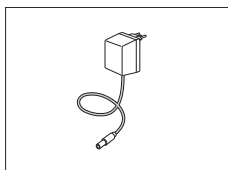

AC/DC universal adapter (EU, USA, AU, UK) 100–240 VAC, 50/60 Hz, 0.5 A, 12 VDC 1 A

11120270

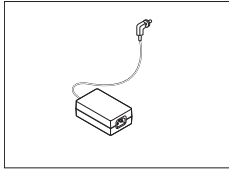

AC/DC adapter (without power cable)

11107909

- Input: 100 – 240 V AC, 50/60 Hz, 0.8 A
- Output: 12 V DC, 2.5 A

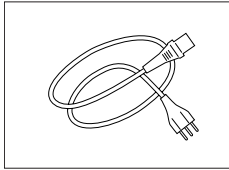

Country-specific 3-Pin power cable with grounding conductor.

Power cable AU	00088751
Power cable BR	30015268
Power cable CH	00087920
Power cable CN	30047293
Power cable DK	00087452
Power cable EU	00087925
Power cable GB	00089405
Power cable IL	00225297
Power cable IN	11600569
Power cable IT	00087457
Power cable JP	11107881
Power cable TH, PE	11107880
Power cable US	00088668
Power cable ZA	00089728

Adjustment weights



OIML / ASTM Weights (with calibration certificate)
see ► <http://www.mt.com/weights>

11.2 Spare parts

Spare parts are parts that are delivered with the original instrument but that can be replaced, if needed, without the help of a service technician.

Balances with readability of 0.0001 ct / 0.01 mg and 0.001 ct / 0.1 mg

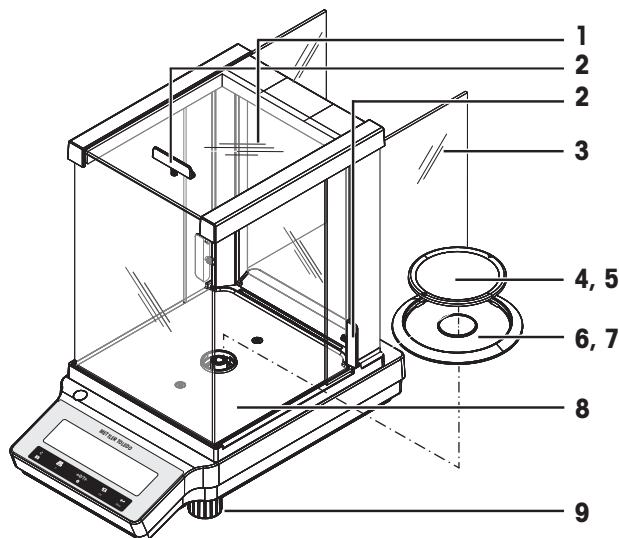

	Order no.	Designation	Remarks
1	30037733	Door top draft shield	Material: Glass; Including: Door handle
2	30037736	Door handles draft shield	Including: 2 door handles
3	30042885	Door left and right draft shield, set	Material: Glass; Including: 2 door handles
4	30098665	Weighing pan \varnothing 80 mm	Including: Pan support
5	30037737	Weighing pan \varnothing 90 mm	Including: Pan support
6	30216708	Draft protection ring	For weighing pan \varnothing 80 mm
7	12122043	Draft protection ring	For weighing pan \varnothing 90 mm
8	30037739	Bottom plate draft shield	–
9	30037744	Leveling foot	Including: 2 leveling feet

Balances with readability of 1 mg

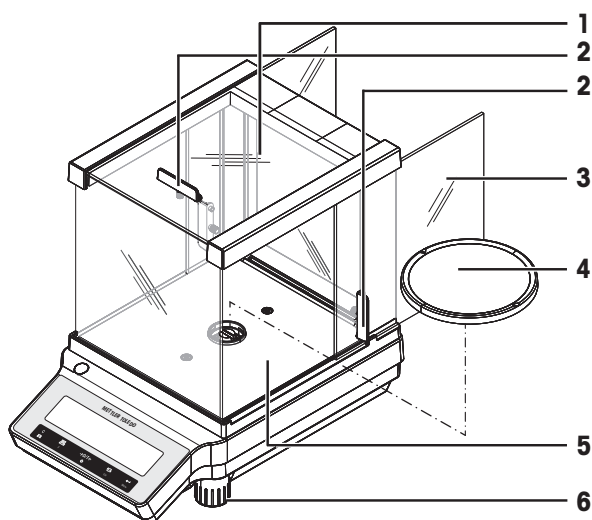

	Order no.	Designation	Remarks
1	30037733	Door top draft shield	Material: Glass; Including: Door handle
2	30037736	Door handles draft shield	Including: 2 door handles
3	30042885	Door left and right draft shield, set	Material: Glass; Including: 2 door handles
4	30042889	Weighing pan \varnothing 120 mm	Including: Pan support
5	30037739	Bottom plate draft shield	–
6	30037744	Leveling foot	Including: 2 leveling feet

ME Balances with readability of 10 mg / 100 mg

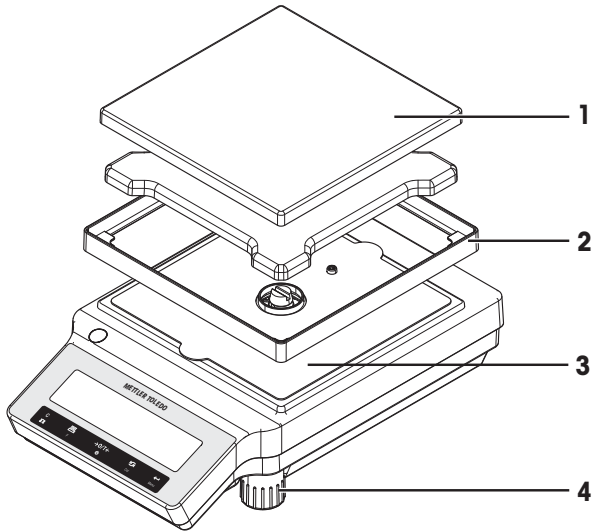

	Order no.	Designation	Remarks
1	30535713	Weighing pan 180 x 180 mm	Excluding: pan support
2	30042897	Draft protection frame 180 x180 mm	–
3	30042901	Bottom plate	Excluding: Screws
4	30037744	Leveling foot	Including: 2 leveling feet

12 Disposal

In conformance with the European Directive 2012/19/EU on Waste Electrical and Electronic Equipment (WEEE) this device may not be disposed of in domestic waste. This also applies to countries outside the EU, per their specific requirements.



Please dispose of this product in accordance with local regulations at the collecting point specified for electrical and electronic equipment. If you have any questions, please contact the responsible authority or the distributor from which you purchased this device. Should this device be passed on to other parties, the content of this regulation must also be related.

Index

Numerics

1/10 d 31

A

AC/DC adapter 71
Accessories 90
Adjusting 22
Adjustment 23
Adjustment lock 33
Advanced menu 30
altitude 71
Application check weighing 44
Application density 54
Application division factor weighing 52
Application icons 10
Application multiplication factor weighing 50
Application percent weighing 42
Application piece counting 39
Application statistics 46
Application totaling 48
Applications 11
Auto print 36
Automatic standby 34
Automatic zero setting 34
Autozero 34
Average (Statistics) 46

B

Backlight 34
Basic menu 30, 31
Basic principles for operation 11
Baudrate 37
below-the-balance weighing 28
Bit/Parity 37

C

Cancel 12
Change settings 12
Char set 38
Check weighing 44
Cleaning 63
Closing the menu 12
convention 3
Customer fine adjustment 23

D

Data communication format 36
Date 21, 31
Date format 33
Density 54
Density kit 54, 90
Density of distilled water 57
Density table for ethanol 58
Dimensions 85, 86
Display 35
Display increment 31
Display panel 10
disposal 96
Distilled water 57
Division factor weighing 52
Draft shield 15, 63, 64

E

End of line 38
Environment 33
environmental condition 14, 71
Ethanol 58
External weight 22

F

Factor weighing 50, 52
Function PC-Direct 59

H

Handles 64
Handshake 38
Header 35
Host 35
humidity 71

I

Icons 10
Identification 32
In use cover
 see protective cover 18
Input principle 12
install
 site 14
Installing
 Handles 64
Installing the components 15

Interface			
MT-SICS		89	
Interface menu		31, 35	
Interface RS232C		35, 89	
Internal weight		22	
Interval		38	
L			
level			
balance		20	
Level indicator		20	
Leveling		20	
Line feed		36	
Liquids		56	
location		14	
Lock adjustment		33	
M			
Main menu		31	
Manual adjustment with external weight		22	
Manual adjustment with internal weight		22	
materials		71	
Menu		31	
Menu advanced		30	
Menu basic		30, 31	
Menu interface		31, 35	
Menu operation		11	
Menu topic		12, 31	
MT-SICS		89	
Multiplication factor weighing		50	
N			
Numerical values		12	
O			
ON / OFF		27	
Operating temperature		20	
Overview balance		8	
P			
PC-DIR		35	
PC-Direct		59	
Percent weighing		42	
Performing a simple weighing		25	
Piece counting		39	
Power supply		71	
see AC/DC adapter		71	
Print		27	
Print menu		32	
Printer		35	
Protective cover		18	
R			
Recall		26, 34	
Reset		33	
RS232C interface		35, 89	
S			
Safety information		5	
Saving settings		12	
Select menu		11	
Select menu topic		12	
Selecting weighing application		11	
Service		34, 63	
Service date reset		34	
Service icon		34	
Service reminder		34	
Set identification		32	
Setting date and time		21	
Setting up the balance		14	
Signature line		36	
Single		36	
Sinker		54	
Solids		54	
spare parts		93	
Standard deviation (Statistics)		46	
Standby		34	
Statistics		46	
Status icons		10	
Stop bit		38	
Submenu		12	
Switching off		27	
Switching weight units		26	
symbol		3	
warning		5	
T			
Taring		26	
Technical data		71	
temperature		71	
Time		21, 31	
Time format		33	
Topic		12, 31	
Totaling		48	
Transmit data		27	
Transport over short distances		28	

Transporting the balance 28

U

Unit 32

W

Warm-up time 20

warning symbol 5

Weighing application 11

Weighing-in aid 27

Weight unit 26, 32

Z

Zero print 36

Zero setting 25

Zeroing 34

GWP®

Good Weighing Practice™

GWP® is the global weighing standard, ensuring consistent accuracy of weighing processes, applicable to all equipment from any manufacturer. It helps to:

- Choose the appropriate balance or scale
- Calibrate and operate your weighing equipment with security
- Comply with quality and compliance standards in laboratory and manufacturing

 www.mt.com/GWP

www.mt.com/jewelry

For more information

Mettler-Toledo GmbH

Im Langacher 44
8606 Greifensee, Switzerland
www.mt.com/contact

Subject to technical changes.
© Mettler-Toledo GmbH 04/2022
30066320G en



30066320